

## ROADS



# 3.1

## ROADS AND BITUMINOUS MIXTURES

### **3.1.1 BITUMINOUS MIXTURES** PAGE 255

---

### **3.1.2 BITUMEN AND EMULSIONS** PAGE 285

---

### **3.1.3 IN SITU TESTS** PAGE 297

---

ITEMS	PAGE	ITEMS	PAGE
Air permeameter	273	Mixers	281-282
Bacon bomb sampler	289	Mot straight edge	303
Ball and ring apparatus	294	Muffle furnace	274
Bath (water)	285	Penetrometer	283-284
Benkelman deflection beam	301	Pensky-martens flash point	295
Binder analysers	279-280	Permeameter for bitumen (MPW)	296
Bitumen extractors	275-278	Plate bearing test equipment.	297-299
Breaking point-Fraas method	287	Polished stone value	302
Centrifuges	275-277	PRD mould	274
Cleveland apparatus	289	Pycnometers	293
Cut back distiller	288	Reflux extractor	276-277
Distillers	287	Roller Compactor	270-271
Ductilometer	295	Rolling thin film oven	286
Elcometer	304	Sand patch apparatus	303
Fraas tester	287	Skid resistance tester	302
Gyratory compactor	272	Solvent recovery still	278
Load rings	257	Thermometers	296
Marshall compactor	267-269	Travelling beam device	304
Marshall testing machine	255-266	Vacuum pump	273
		Viscometers	290-292

## 50 kN MARSHALL TESTING MACHINES

ASTM D 1559 AASHTO T 245 BS 598 CNR 30  
EN 12697-12 EN 12697-34

Tecnotest manufactures various models: a continuous, variable-speed machine (T 052/E), a six-speed machine (T 051), a fixed-speed machine (B 050).

### VARIABLE SPEED TESTING MACHINE 50 kN T 052/E

The special characteristic of the machine consists in its variable speed operating within a continuous range (from 0.01 to 52 mm/min.). Speed change is via keyboard.

Platen speed is shown on the display.

Load and deformation (displacement) control: for test procedures requiring constant deformation rate, speed must be input at the start. The closed-loop control maintains this speed during the test irrespective of load. Feedback control may also be extended to load so as to enable tests that require a constant load rate to be performed. In this case rate must be input at the start of the test: automatic control will ensure that this rate is maintained during the test irrespective of deformation.

Safety devices limit cylinder stroke while controlling stability measuring instrument and mould.

Max. vertical span: 800 mm, minimum 100 mm.

Horizontal span: 380 mm.

Ram travel: 100 mm.

**Given the range of operating speeds, the machine can be used for other tests, such as compression tests on soil-bituminous mixes, C.B.R., soil-cement mixes and flexural test on concrete, mortar, natural stones, clay blocks and tiles, as well as for quick triaxial tests.**

The control system unit is our microprocessor-based, two channel EUOTRONIC with two extra channels as optional. When connected to a loading cell and transducer it controls the test, data acquisition, processing, storage, display as well as downloading to a PC.

Specifications on the following pages.

POWER SUPPLY: 220 V, 50 Hz, 1 ph, 1 kW.

DIMENSIONS: 520 x 550 x 1450 (h) mm.

WEIGHT: 160 kg.

#### THE MACHINE HAS TO BE COMPLETED WITH:

AP 032/050	Load cell (50 kN)
AD 115/026	Displacement transducer: 25 mm travel (0,01)
BA 201	Load penetration piston
T 630 - T 630/2	Transducer bracket and extension
B 005/T	Breaking head stability mould (for Marshall test)
T 628/A	Mould (for CBR test)



T 052/E  
EQUIPPED FOR  
CBR TEST

AP 032/050	LOAD CELL
AD 115/026	TRANSDUCER
T 630, T 630/2	BRACKETS
BA 201	PENETRATION PISTON
T 628/A	CBR MOULD

T 052/E  
EQUIPPED FOR  
MARSHALL TEST



AP 032/050	LOAD CELL
AD 115/026	TRANSDUCER
T 630, T 630/2	BRACKETS
BA 201	PENETRATION PISTON
B 005/T	BREAKING HEAD STABILITY MOULD

### 3.1.1 BITUMINOUS MIXTURES



<b>T 051</b>	<b>TESTING MACHINE</b>
<b>BB 050</b>	<b>PROVING RING</b>
<b>BA 201</b>	<b>PENETRATION PISTON</b>
<b>B 005/A</b>	<b>BRACKET</b>
<b>T 628/E 1</b>	<b>DIAL GAUGE</b>
<b>B 005/T</b>	<b>BREAKING HEAD STABILITY MOULD</b>



<b>B 050</b>	<b>MARSHALL TESTING MACHINE</b>
<b>AD 200</b>	<b>EUROTRONIC</b>
<b>AP 032/050</b>	<b>LOAD CELL</b>
<b>AD 115/026</b>	<b>TRANSDUCER</b>
<b>T 630</b>	<b>BRACKET FOR DIAL GAUGE/TRANSDUCER</b>
<b>T 630/2</b>	<b>EXTENSION FOR TRANSDUCER</b>
<b>BA 201</b>	<b>PENETRATION PISTON</b>
<b>BA 201/B39</b>	<b>PISTON EXTENSION</b>
<b>B 005/T</b>	<b>BREAKING HEAD STABILITY MOULD</b>

### TECNOTEST

#### 50 kN VARIABLE SPEED MACHINE (6 SPEEDS)

T 051

The special characteristic of the machine consists in its 6 speeds (pre-set in a range from 0.6 to 50.8 mm/min.).  
Speeds: 0.635 - 1 - 1.27 - 5 - 25.4 - 50.8 mm/min.  
The speed change is made via keyboard.  
Max vertical span 600 mm, minimum 100 mm.  
Horizontal span 380 mm.  
Ram travel 100 mm.

#### Particularly suitable for the following tests:

MARSHALL	Piston speed 2"/min. (50.8 mm)
HUBBARD-FIELD	Piston speed 1"/min. (25.4 mm)
C.B.R. (ASTM)	Piston speed 0.05"/min. (1.27 mm)
C.B.R. (BS)	Piston speed 1 mm/min.
UNCONFINED	Piston speed 0.025"/min. (0.635 mm)

The machine can be used for other tests.

**POWER SUPPLY:** 220 V, 50 Hz, single phase, 750 W.

**DIMENSIONS:** 520 x 550 x 1250 (h) mm.

**WEIGHT:** 156 kg.

**ACCESSORIES FOR MARSHALL TEST: PAGE 28**

**ACCESSORIES FOR UNCONFINED TEST: PAGE 33**

#### MARSHALL TESTING MACHINE 50 kN

B 050

The platen is raised at a constant rate by means of an electric motor.  
TEST SPEED 50.8 mm (2")/minute.

Maximum span between columns 280 mm.

Vertical span: maximum 480 mm, minimum 300 mm.

Safety devices limit cylinder stroke while controlling stability measuring instrument and mould.

Magnetothermal switch and lever for upstroke/downstroke of the test platen.

**POWER SUPPLY:** 220 V, 50 Hz, single phase, 750 W.

**DIMENSIONS:** 500 x 450 x 1400 (h) mm.

**WEIGHT:** 110 kg.

#### ACCESSORIES FOR MARSHALL TEST:

<b>B 005/T</b>	<b>BREAKING HEAD, cast iron</b> Dimensions: 140 x 165 x 175 (h) mm Weight: 7.5 kg
----------------	---

The machine (T 051 - B 050) is supplied without measuring devices or accessories for the test, so they should be ordered separately.  
The machine is available in analog and digital versions.

## LOAD MEASURING SYSTEMS

### LOAD PROVING RINGS

The proving rings are used as calibration instruments (dynamometers) and load measuring devices for laboratory testing machines. Made of special steel subjected to heat-treatment to improve the elastic properties.

A dial gauge (RAMBOLD original) is positioned within the proving ring to read its deformation which is expressed in 0.001 mm.

Each BA model proving ring (with relevant dial gauge) is calibrated by an Accredited Laboratory which issues a CALIBRATION CERTIFICATE. The BB model proving rings are calibrated in Tecnotest's laboratory and are supplied with in-house certificate.

MODELS		N	kg
BA 001	BB 001	1000	100
BA 002	BB 002	2000	200
BA 003	BB 003	3000	300
BA 005	BB 005	5000	500
BA 006	BB 006	6000	600
BA 010	BB 010	10000	1000
BA 020	BB 020	20000	2000
BA 030	BB 030	30000	3000
BA 040	BB 040	40000	4000
BA 050	BB 050	50000	5000



BA 005

BA 040

BA 050

### EXTENSOMETRIC LOAD CELLS

Extensometric, type - high precision - stainless steel made, high resistance, cylindrical shape. Thermal compensation.

Linearity - hysteresis	$\leq \pm 0.03$ % F.S.
Repeatability	(%) $\leq \pm 0.01$ F.S.
Nominal sensitivity	(mV/V) 2
Recommended supply voltage	(V) 10
Protection class	(EN 60529) IP67

MODEL	N	kg
AP 032/003	3500	350
AP 032/005	5000	500
AP 032/010	10000	1000
AP 032/025	25000	2500
AP 032/050	50000	5000
AP 032/075	75000	7500
AP 032/100	100000	10000

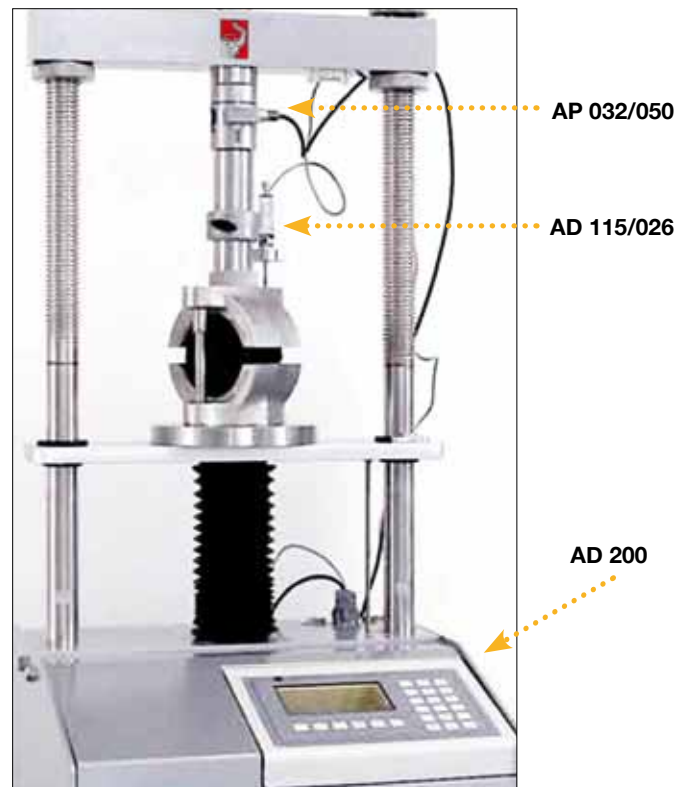

AP 032/050

AD 115/026

AD 200

## FLOW MEASUREMENTS DEVICES

### MECHANICAL

T 628/E	Dial gauge, 30 mm travel - 0.01 divisions
T 630	Bracket for dial gauge/transducer with micrometric screw for zero setting

**N.B.:** On purchasing our load cells or transducers, together with readout units, initial calibration of system is performed free of charge in Tecnotest's Metrological laboratory.

### ELECTRIC

AD 115/026	Potentiometric transducer 25 mm travel, 0.01 mm sensitivity
T 630	Bracket for dial gauge/transducer with micrometric screw for zero setting
T 630/2	Extension to T 630 for transducer

## COMPUTERIZED MARSHALL TEST

An extremely interesting feature of our machines is the possibility of using a PC interface in order to acquire test data automatically. Provided that the machines are fitted our Eurotronic control/display unit and electronic transducers, an automatic data acquisition system may be implemented, thus enabling such data to be subsequently processed and to provide a test certificate (also in hard copy version if a printer is connected).

PC and printer, if not available, should be sourced locally.

**Various types of data acquisition software are available:**

**AD 050/001 DATA ACQUISITION SOFTWARE**

**AD 050/B11 DATA ACQUISITION AND PROCESSING SOFTWARE FOR MARSHALL TEST**

**AD 050/B13 DATA ACQUISITION AND PROCESSING SOFTWARE FOR INDIRECT TENSILE TEST**

### AD 050/001

This software enables acquisition by a PC of test data (time, load, displacement) from the Eurotronic.

Data thus transmitted are collected in a file which can be opened using a MS Windows application (such as MS Excel) for subsequent graphic processing.

### AD 050/B11 and AD 050/B13

These two types of software enable acquisition by a PC of test data (time, load, displacement) from the Eurotronic.

Data thus transmitted are collected in a file which can be opened using a MS Windows application (such as MS Excel) for subsequent graphic processing.

Data are also sent to an MS Access module for automatic processing of test certificate and graph. All tests are gathered in an MS Access data base which is easy to consult. Some customization of software is also possible.

Using this software, the laboratory letter head and logo may also be included in the test certificate.

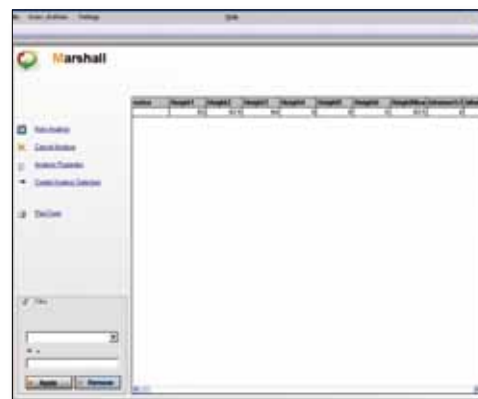
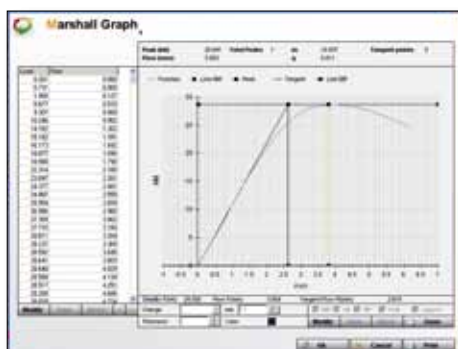
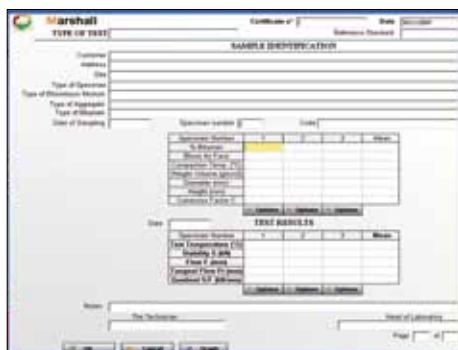



## INDIRECT TENSILE TEST

**DEVICE FOR Ø 100 mm (4") SPECIMEN** **B 006**

EN 12697-23

For determining the splitting tensile strength and the strain of a Marshall specimen. The apparatus is complete with bearers for Ø 100 mm (4") samples.

Interchangeable bearers for other diameters are available.

**DIMENSIONS:** 210 x 210 x 260 (h) mm.

**WEIGHT:** 7 kg.

**DEVICE FOR Ø 100 mm (4") SPECIMEN** **B 008**

CNR 134

The apparatus, designed by Tecnotest, includes the mobile support for horizontally-positioned transducer.

The transducer, which is supplied separately, is sufficient to obtain horizontal deformation measurement without needing to resort to the means of two diametrically opposed measurements. Interchangeable bearers for other diameters are available. For measurement of horizontal deformation we suggest:

**AD 115/026** Displacement transducer 25 mm travel (0.01)

**DIMENSIONS:** 210 x 390 x 260 (h) mm.

**WEIGHT:** 7 kg.

### ACCESSORIES FOR B 006 AND B 008 :

**B 007/10** Kit of two bearers for Ø 100 mm (4") specimens

**B 007/15** Kit of two bearers for Ø 150 mm (6") specimens

**B 007/16** Kit of two bearers for Ø 160 mm specimens

**AD 050/B13** DATA ACQUISITION AND PROCESSING SOFTWARE FOR INDIRECT TENSILE TEST

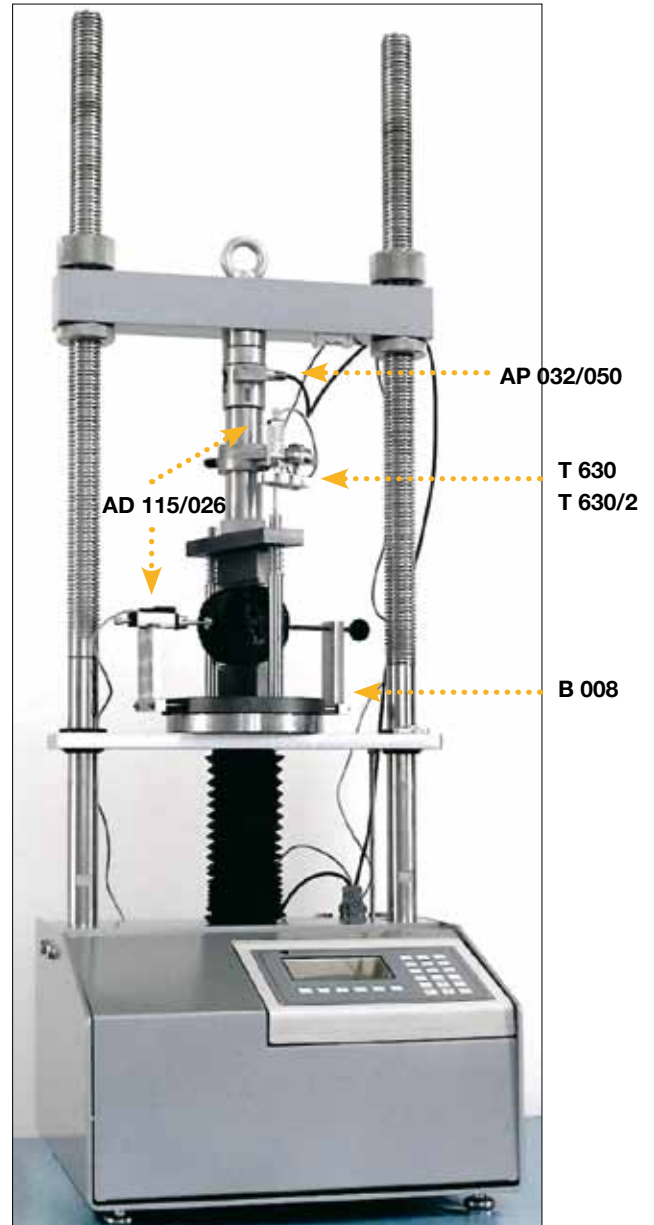

T 052/E



B 008 + TRANSDUCER

## VARIOUS CONFIGURATIONS FOR T 052/E MULTITEST MACHINE

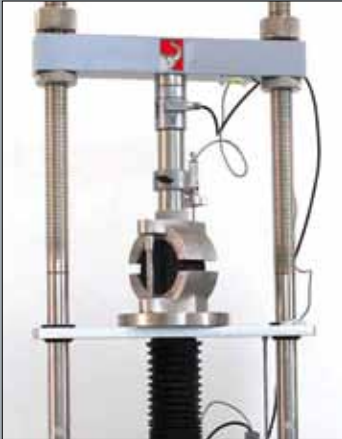

### 1. MARSHALL TEST

AP 032/050	LOAD CELL (50 kN)
BA 201	PENETRATION PISTON
AD 115/026	ELECTRONIC TRANSDUCER, 25 mm TRAVEL
T 630	BRACKET FOR DIAL GAUGE/TRANSDUCER
T 630/2	EXTENSION TO T 630 FOR TRANSDUCER
B 005/T	BREAKING HEAD STABILITY MOULD



### 2. ASPHALT INDIRECT TENSILE TEST WITH MEASUREMENT OF HORIZONTAL AND VERTICAL DEFORMATION

AP 032/050	LOAD CELL (50 kN)
BA 201	PENETRATION PISTON
AD 115/026	ELECTRONIC TRANSDUCER, 25 mm travel (2 pieces)
T 630	BRACKET FOR DIAL GAUGE
T 630/2	EXTENSION TO T 630 FOR TRANSDUCER
B 008	DEVICE for Ø 100 mm (4")

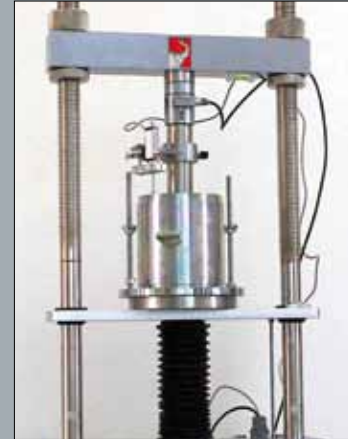

### 3. CBR TEST

AP 032/050	LOAD CELL (50 kN)
BA 201	PENETRATION PISTON
AD 115/026	ELECTRONIC TRANSDUCER, 25 mm travel
T 630	BRACKET FOR DIAL GAUGE/TRANSDUCER
T 630/2	EXTENSION TO T 630 FOR TRANSDUCER
T 628/A	CBR MOULD



### 4. SOIL-CEMENT INDIRECT TENSILE TEST

AP 032/050	LOAD CELL (50 kN)
KR 023	INDIRECT TENSILE STRESS TESTING DEVICE
BA 201	PENETRATION PISTON
KR 024/C	HARD BOARD PACKING STRIPS

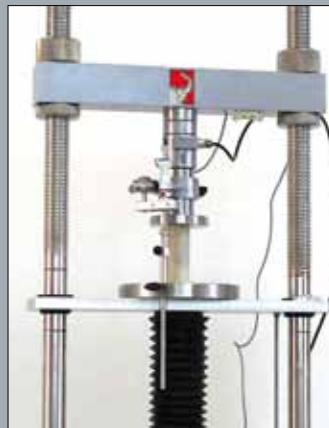

### 5. UNCONFINED TEST

AP 032/050	LOAD CELL (50 kN)
T 630/5	COMPRESSION PLATE
T 630/3	DIAL GAUGE/TRANSDUCER DATUM BAR
AD 115/026	ELECTRONIC TRANSDUCER, 25 mm travel
T 630	BRACKET FOR DIAL GAUGE/TRANSDUCER
T 630/2	EXTENSION TO T 630 FOR TRANSDUCER



### 6. QUICK TRIAXIAL TEST

AP 032/005	LOAD CELL: 5 kN SUPPLIED WITH SMALL THRUST PISTON AND RELEVANT TRANSDUCER BRACKET
T 630/2	EXTENSION TO T 630 FOR TRANSDUCER
AD 115/026	ELECTRONIC TRANSDUCER, 25 mm travel
TR 205	TRIAXIAL CELL

## VARIOUS CONFIGURATIONS FOR T 052/E MULTITEST MACHINE

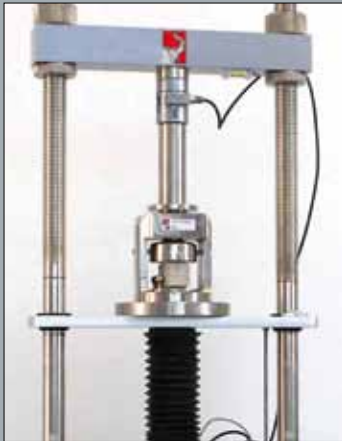

### 7. CEMENT/MORTAR COMPRESSION TEST

AP 032/050	LOAD CELL (50 kN)
BA 201	PENETRATION PISTON
C 362/N	COMPRESSION TESTING DEVICE

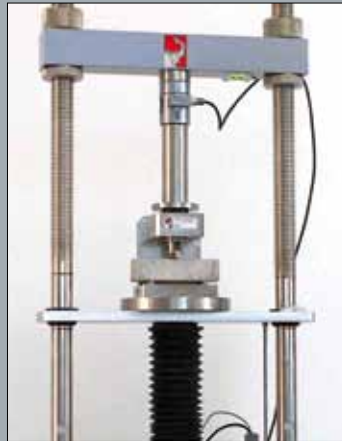

### 8. CEMENT/MORTAR FLEXURAL TEST

AP 032/050	LOAD CELL (50 kN)
BA 201	PENETRATION PISTON
C 362/F	FLEXURE TESTING DEVICE

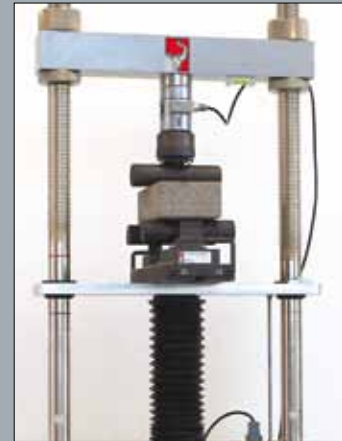

### 9. NATURAL STONES FLEXURAL TEST

AP 032/050	LOAD CELL (50 kN)
KR 005/EN	FLEXURAL TESTING DEVICE TO EN 12372



### 10. CONCRETE BEAM FLEXURAL TEST

AP 032/050	LOAD CELL (50 kN)
BA 201	PENETRATION PISTON
KR 08	FLEXURAL TESTING DEVICE FOR CONCRETE BEAMS



### 11. CONCRETE TILES AND BLOCKS FLEXURAL TEST

AP 032/050	LOAD CELL (50 kN)
P 406/3	UPPER FLOATING BEARER
P 406/2	PAIR OF LOWER BEARERS
P 406/T	BEARERS SUPPORTING BEAM



### 12. CLAY BLOCKS PUNCHING TEST

AP 032/050	LOAD CELL (50 kN)
P 406/1	HARD WOODEN BLOCK
P 406/2	PAIR OF LOWER BEARERS
P 406/T	BEARERS SUPPORTING BEAM

### Other tests possible using T 052/E:

#### UNIAXIAL TEST ON SOILS

AP 032/050	LOAD CELL (50 kN)
T 630/5	COMPRESSION PLATE

#### COMPRESSION TEST ON SOIL-CEMENT SAMPLES

AP 032/050	LOAD CELL (50 kN)
T 630/6	COMPRESSION PLATEN, 155 mm diameter

#### ASPHALT INDIRECT TENSILE TEST "EN"

AP 032/050	LOAD CELL (50 kN)
BA 201	PENETRATION PISTON
B 006	DEVICE for Ø 100 mm (4")



## BUYER'S GUIDE

	ANALOG VERSION	DIGITAL VERSION	ANALOG VERSION	DIGITAL VERSION
<b>TESTING MACHINE (50 kN)</b>	<b>FIXED SPEED</b>	<b>FIXED SPEED</b>	<b>6 SPEEDS</b>	<b>VARIABLE SPEED</b>
MARSHALL TESTING MACHINE	B 050	B 050	T 051	T 052/E
<b>LOAD MEASUREMENT</b>				
PROVING RING 5000 kg	BB 050		BB 050	AP 032/050
LOAD CELL 50 kN		AP 032/050		
PENETRATION PISTON	BA 201	BA 201	BA 201	BA 201
DIGITAL READOUT UNIT - EUROTRONIC		AD 200		
<b>DEFORMATION MEASUREMENT</b>				
DIAL GAUGE, 10 mm travel	T 628/E1		T 628/E1	
ELECTRONIC TRANSDUCER, 25 mm travel		AD 115/026		AD 115/026
BRACKET FOR DIAL GAUGE/TRANSDUCER	B 005/A	T 630	B 005/A	T 630
EXTENSION TO T 630 FOR TRANSDUCER		T 630/2		T 630/2
EXTENSION TO PENETRATION PISTON		BA 201/B39		
<b>DATA ACQUISITION</b>				
DATA ACQUISITION SOFTWARE		AD 050/001		AD 050/001
DATA ACQUISITION AND PROCESSING SOFTWARE FOR MARSHALL TEST (WINDOWS)		AD 050/B11		AD 050/B11
<b>ACCESSORIES FOR MARSHALL TEST</b>				
BREAKING HEAD STABILITY MOULD	B 005/T	B 005/T	B 005/T	B 005/T
DATA ACQUISITION AND PROCESSING SOFTWARE FOR MARSHALL TEST (WINDOWS)		AD 050/B11		AD 050/B11
<b>INDIRECT TENSILE TEST (EN)</b>				
COMPRESSION DEVICE $\varnothing$ 100 mm samples			B 006	B 006
<b>ACCESSORIES FOR C.B.R. TEST</b>				
DIAL GAUGE 25 mm travel			T 628/E	
BRACKET FOR DIAL GAUGE			T 630	
<b>UNCONFINED COMPRESSION TEST</b>				
COMPRESSION PLATEN			T 630/5	T 630/5
DIAL GAUGE/TRANSDUCER HOLDER			T 630/3	T 630/3

## EUROTRONIC (AD 200)

### HARDWARE FEATURES

- 24 VDC power (supplied with mains adaptor 110/220 V)
- 320 x 240 pixel backlit display complete with energy save feature
- 4 Channels which may be set at 2 mV/V, 3 mV/V, 7 mV/V or 10 VDC: each channel has a resolution of 500000 points
- 24 Button keyboard, including a numeric keypad, for quick test selection and easy data input, more practical than the minimalistic models with fewer buttons
- 8 Digital inputs
- 8 Digital outputs
- 2 Pulse width modulation output (PWM) for stepper or brushless motor control
- 2 Analog outputs (12 bits – 0/10 Volts) for closed-loop feedback control
- 1 Serial RS-232 port and 2 serial RS-485 ports for transmitting data to a PC in real time or at the end of test
- 1 Slave USB port for transmitting data to a PC or for uploading software upgrades or custom modifications to software in use
- 1 Master USB port for connecting to a USB data stick
- 1 Ethernet port or Wi-Fi port for data transmission or remote control

The Eurotronic is one of the few instruments (if not the only one) in the market to have a numeric keypad for data input. To enter a number there is no need to call up the number required by first scrolling up or down using arrow keys, as it is sufficient to input it via the numeric keypad.

### SOFTWARE FEATURES

- Selectable languages: Italian, English, Spanish, French, Portuguese, Russian (Cyrillic alphabet), Polish and Rumanian. All test pages are translated, including those sent to PC or printer
- Selectable units of measurement: kN, N, lbf, tonnes, kgf, mm, in. The instrument automatically converts values in one unit of measurement to another without any need for recalibration
- Display of test graph in real time
- Transmission to PC to test data in real time with data time scan selection (1 datum per second, 2 data per second, 5 data per second, 10 data per second, 1 datum every 10 seconds)
- Tests performed are stored in an archive
- Archive with scroll index for tests performed: it is possible to send to a PC test results only or all test data foreseen, time/load/displacement, for subsequent processing in graph format
- Clock and calendar with daylight saving hour foreseen
- Memorizes for each test: time, user ID, sample parameters and serial number, test results
- Special functions, protected by password, for verification of functioning of keyboard, A/D inputs, inputs and outputs

### CALIBRATION

Tecnotest has taken special care as usual to ensure that maximum readout accuracy of its calibration function is guaranteed.

The calibration function is obviously protected by a password. Calibration is performed over 11 programmable points from zero to full scale of the instrument under calibration.

The procedure is particularly simple and designed so that there is no need for calculation of coefficients, to enter them by hand or to repeat procedures on a trial and error basis.

In practice, the user is invited to explore the entire readout scale, then to press a key when the sample dynamometer indicates exactly 0, 10%, 20%.....90%, 100% relative to full potential of the machine.

The instruments suggests memorizing 11 points equally distributed along the readout scale, but these may be modified as desired : for example, it may be decided to memorize points 0, 1%, 5%, 10%, 20%.....80%, 100% of full scale thus guaranteeing, thanks to the 500000 divisions available, high precision even at very low loads. All these operations are extremely simple and quick to perform thanks to the unit's function keys and numeric keypad.



AD 200

### ACCESSORIES

AD 200/ETH	Ethernet port
AD 200/WFI	Wi-Fi port

NB: Implementation of any one of the optional ports (not both) is possible only at the time the AD 200 is ordered, not once delivered, so choice of port must be specified, if required, at time of order.

### 3.1.1 BITUMINOUS MIXTURES

### TECNOTEST

#### TEST SCREENS

Eurotronic has the following test routines:

- Manual mode
- Compression test on cubes, cylinders, blocks
- Flexural tests with 3 or 4 point loading
- Tensile test
- Block pavers test
- Marshall test
- CBR test
- Indirect tensile test for asphalt
- Unconfined test
- Failure under controlled loading
- Failure under controlled test speed

For each test previous considerations are valid (see software features)

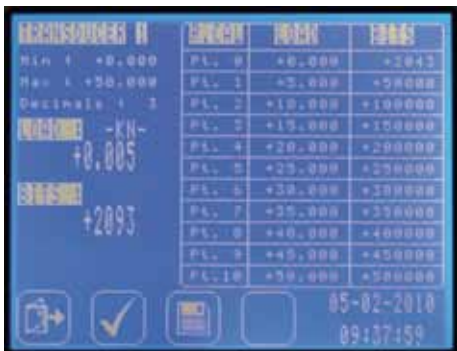

#### Compression test:

Graph display in real time, automatic calculation of sample strength at end of test. In automatic machines test start, test speed management and test stop with calculation of results are all, obviously, completely automatic. If numerous tests are to be performed on samples of equal shapes and sizes, a simple touch of a key allows other tests to be performed again and again without having to repeat input of sample parameters.

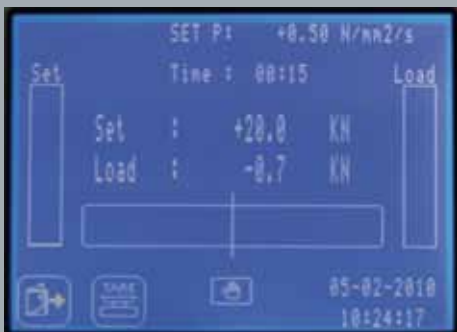

#### Flexural test:

Four types of flexural tests may be selected. Centre point or two point testing via input of parameters relative to base and height of sample or via input not only of base and height but also section.

**Marshall test:**

Automatic calculation of Marshall stability with correction of height of sample, flow and tangential according to EN or ASTM Standard procedures. Allows change of peak position and tangent and consequently recalculates test results. Time/load/flow data are sent to a PC at a rate of 10 data per second in real time or from archive after backup.

Start threshold setup and automatic test stop.

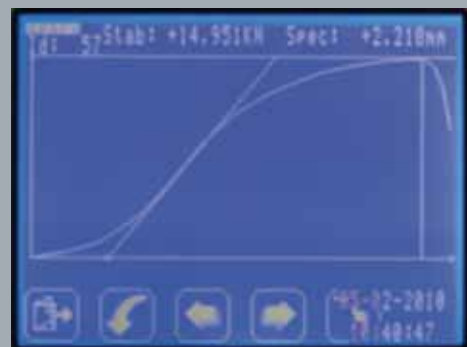
**CBR test:**

Automatic calculation of CBR value at 2.5 mm and at 5 mm per second. Graph display. Allows correction of tangent position and subsequent recalculation of CBR value.

Start threshold setup and automatic test stop.

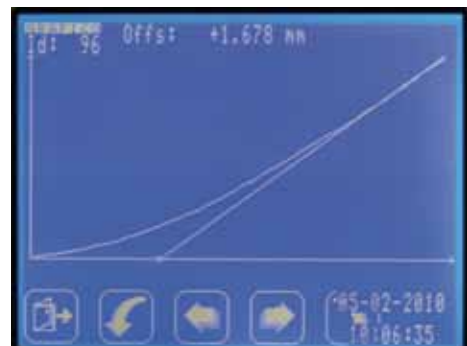



### 3.1.1 BITUMINOUS MIXTURES

#### TECNOTEST



#### Indirect tensile test on asphalt:

Test is performed calculating only failure load, with calculation of failure and axial deformation or failure calculation and axial and diametral deformation calculation.

Start threshold setup and automatic test stop.



#### Unconfined test:

Calculation of failure load and deformation. Graph display possible to individuate point of failure of sample.

Start threshold setup and automatic test stop.



#### Failure under load control:

Generic test function which foresees readout of a load to apply on a sample.

It is possible to manage and display test speed.

Start threshold setup and test stop are optional.



#### Failure under load speed control:

Test function which foresees readout of a load and deformation.

It is possible to display load and deformation speeds.

It is possible to perform tests under load speed control or under deformation speed control



#### Manual mode:

Generic routine for displaying one, two, three or four channels, also allowing memorization of peak. This routine is particularly useful for checking calibration.

## AUTOMATIC COMPACTOR

ASTM D 1559 CNR 30

Wooden pedestal manufactured in compliance with standards with base connections to secure the machine to the floor.

Tubular steel frame housing the driving mechanism of the compaction rammer. Steel base plate (compaction anvil for hammer); mould clamping system with quick couplings. Drive rod fixed to the base by means of self-centering locking system. Compaction rammer of 4,535 kg (10 lb) raised to a height of 457.2 mm (18") and allowed to drop.

Electric control panel with automatic blow counter for presetting of the required number of blows and automatic stop.

Base plate with handles model B 518/5 for compaction mould is included.

Safety protection, made of steel complete with relevant micro-switches.

**The mould B 518 is not included.**

**DIMENSIONS:** 400 x 400 x 1400 (h) mm.

**WEIGHT:** 80 kg.

### MODELS:

<b>B 516</b>	AUTOMATIC COMPACTOR Power supply: 220 V, 50 Hz, single phase, 180 W
<b>B 516/1</b>	AUTOMATIC COMPACTOR Power supply: 110 V, 60 Hz, single phase, 180 W



**B 516**

### SOUND-PROOFING CABINET

**B 516/P**

For reducing the noise level to below 75 dB thus permitting operator exposure to be increased from one hour to the whole working day.

The control panel is located on the outer wall.

Bearing frame is in anodized aluminium with double-walled, insulated panels in galvanized sheet metal.

Door is locked by key.

**DIMENSIONS:** 800 x 690 x 1980 (h) mm.

**WEIGHT:** 165 Kg.



**B 516  
B 516/P**

### 3.1.1 BITUMINOUS MIXTURES

#### TECNOTEST



B 515 - B 518/5 - B 518



B 515/C - B 518/5



B 518/1

B 518/2

B 518/3



B 518/5



B 520

#### **HAND-OPERATED COMPACTOR**

**B 515**

Similar to model B 516, but without geared motor, mechanic devices and electric system.

This compactor consists of:

- wooden pedestal with rammer drive rod
- compaction rammer, consisting of centering rod and tamping ram (4,535 kg).
- steel base (compaction anvil)
- mould clamping system with quick couplings.

**The mould B 518 is not included.**

**DIMENSIONS:** 400 x 250 x 1500 (h) mm.

**WEIGHT:** 50 kg.

#### **PORTABLE COMPACTOR (hand-operated)**

**B 515/C**

Without doubt the "handiest" system for the compaction of Marshall specimens.

Ideal for the preparation of specimens in situ.

The compactor consists of:

- wooden pedestal
- compaction rammer (centering rod and 4.535 kg tamping ram).
- steel base (compaction anvil)
- mould clamping system with quick couplings.

**The mould B 518 is not included.**

**DIMENSIONS:** 420 x 250 x 1450 (h) mm.

**WEIGHT:** 32 kg.

#### **MARSHALL MOULD**

**B 518**

Made of zinc-plated steel, consisting of the actual mould body [diameter 4" x 3" (101.6 x 76.2 mm)], base plate and filling collar.

**DIMENSIONS:** diameter 115 x 155 (h) mm

**WEIGHT:** 3.5 kg

The three parts can be supplied individually:

**B 518/1** Circular base plate for mould

**B 518/2** Mould body

**B 518/3** Filling collar for mould

#### **SQUARE BASE PLATE FOR MOULD**

**B 518/5**

For use with the automatic or hand-operated compactor. Complete with handles.

**B 570/M** PAPER DISKS 100 mm diameter (100 pcs box)

#### **HAND-OPERATED HYDRAULIC EXTRUDER**

**B 520**

Hand-operated hydraulic jack, 3 t capacity. Suitable for the extrusion of 4" diameter specimens from the mould.

**DIMENSIONS:** 200 x 200 x 400 (h) mm.

**WEIGHT:** 20 kg.

**AUTOMATIC COMPACTOR****B 517/A**

EN 12697-10 EN 12697-30

The machine performs compaction on hot samples of bituminous mixture, stopping after the preset number of blows.

The anvil in laminate hardwood is connected to the base in concrete which also supports the drive rod.

The compaction mould is held in position by a quick-clamping device as prescribed by Standards; a safety door with stop switch guarantees operator security.

For soundproofing a special cabinet is available (see optional accessory B 517/P).

**The mould B 523 is not included.**

**Specifications:**

- compaction rammer weight  $4540 \pm 10\text{g}$
- dropping height  $457 \pm 3\text{ mm}$
- blow frequency as prescribed by standard
- anvil  $203 \times 203 \times 453\text{ mm}$ , density  $0.67 \div 0.77$
- base in reinforced concrete  $450 \times 550 \times 200\text{ (h) mm}$

**POWER SUPPLY:** 220 V, 50 Hz, single phase, 180 W

**DIMENSIONS:**  $450 \times 550 \times 1960\text{ (h) mm}$

**WEIGHT:** 270 kg.

**COMPACTION MOULD****B 523**

Zinc plated steel; consisting of the actual mould body,  $\varnothing 101.6\text{ mm}$ , base plate and collar.

The three parts can be supplied individually:

<b>B 523/1</b>	Circular base plate for mould with handles
<b>B 523/2</b>	Mould body
<b>B 523/3</b>	Filling collar for mould

**ACCESSORIES:**

<b>B 523/4</b>	Circular base plate for mould (without handles)
<b>B 523/5</b>	Steel plate for mould: dia. $100 \times 50\text{ (h) mm}$ Used for heating the anvil
<b>B 523/6</b>	Storage tray for 6 moulds
<b>B 570/M</b>	Paper disks $100\text{ mm dia.}$ (100 pcs box)

**SOUND-PROOFING CABINET****B 517/P**

For reducing the noise level to below 75 dB thus permitting operator exposure to be increased from one hour to the whole working day.

The control panel is located on the outer wall.

Bearing frame is in anodized aluminium with double-walled, insulated panels in galvanized sheet metal.

Door is locked by key.

**DIMENSIONS:**  $750 \times 1030 \times 1980\text{ (h) mm.}$

**WEIGHT:** 220 kg.

**B 517/A**  
**B 523****B 523/1****B 523/2****B 523/3****B 517/P**  
**B 517/A**



**ROLLER COMPACTION AND WHEEL TRACKING APPARATUS****B 120/B26**

EN 12697-33 EN 12697-22

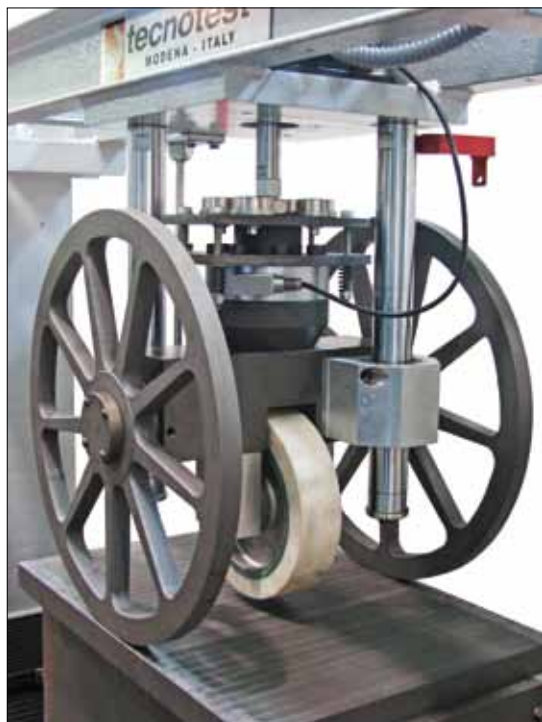

Detailed view of roller compactor function of B 120/B26



Detailed view of wheel-tracking function of B 120/B26

The special feature of the machine is the integration of two distinct functions in a single system; the first allows the compaction of slabs of bituminous mixtures to a controlled density, the second is for performing the wheel tracking test. A “kneading” system is used for compaction and consists in positioning between the roller and bituminous mixture a series of sliding metal plates that are free to move vertically, guided by the internal mould surfaces. The wheel tracking test apparatus is the “small-size” type prescribed in the Standard.

The integration of the two functions is made possible by the particular machine design (patented); the cylindrical roller is replaced with two coaxial disks rolling along lateral projections of the sliding plates. On removing the plates, the disks are lowered over the two other edges of the mould, so contact between the bituminous mixture surface and the wheel of the wheel-tracking apparatus is made.

As for the mechanics, the machine is composed by a horizontal axis driven by a brushless motor coupled with a ball-screw assembly and by a vertical axis driven by a Bellofram cylinder controlled by a pneumatic servo-valve.

There are three sensors installed in the machine: an incremental encoder for the horizontal axis position, a magnetostrictive sensor for the vertical axis position, and a load cell for force.

Each of these sensors can be used as reference by the closed-loop, computer controlled system with feedback; the user interface is a touch screen.

The test area is enclosed within a ventilated climatic chamber with automatic thermo-regulation up to 60°C.

**ROLLER COMPACTOR**

In order to obtain slabs of the desired density and size, an initial levelling cycle may be actuated that is intended for evenly distributing the mix in the mould.

The compacting phase may be programmed with constant or increasing load, i.e. with increasing deformation. It is possible to set a defined slab thickness or the number of cycles.

**WHEEL TRACKING**

The refined system of transduction, control and actuation of the roller compactor remains active during wheel tracking test in order to compensate, insofar as it is possible, the inertial effects of load mass due to irregularities in rut depth. Both the procedures prescribed by Standards may be performed.

**USER INTERFACE**

Users are required to input basic parameters and procedures; test execution, measurements, data processing and test report compilation are completely automatic.

**POWER SUPPLY:** 380 V, 50 Hz, 16 A, three phase + N + E, 6000 W

**AIR SUPPLY:** 10 bar pressure; dry, non-lubricated air (compressor and accessories are not supplied)

**DIMENSIONS:** 1850\* x 800 x 1990 (h) mm

**WEIGHT:** 800 kg

\*Overall length: (with monitor fully extended) is 2300 mm



B 120/B26



MOULD TROLLEY

## 3.1.1 BITUMINOUS MIXTURES

## TECNOTEST



B 100



B 100/1F

## GYRATORY COMPACTOR

B 100

EN 12697-10 EN 12697-31 ASTM D 6307 SHRP M 02

Approved by the south Central Superpave Center - "comparable 12 out of 12 times, a perfect rate of comparison".

The Gyratory Compactor, which produces consistent replication of the testing environment from test to test, includes a Pentium-based PC, calibration equipment and software at no additional cost. The compaction chamber is completely enclosed. Continuous height measurement of the specimen during compaction to within  $\pm 0.1$  mm.

Built-in power-assisted specimen extractor means no hand pumping. Work area which allows user to charge the mold, compact the specimen and extract it without lifting the mold. Real-time display of data. User-friendly software programs for editing, test data acquisition and analyzing test data. See-through door and illuminated chamber allow continuous observation of compaction cycle.

Safety switch which stops gyration when guard door is open. Emergency stop button. Quick, easy mold alignment.

100 mm and 150 mm molds are accepted.

Complete with 150 mm Gyratory Mold, 150 mm Mold Bottom, 150 mm Piston Face, IBM compatible computer pre-loaded with Windows operating system. Gyratory Software, Gyratory Calibration Device, and 150 mm dia. paper Disc (N° 500).

**Specifications:**

**Consolidation Pressure:** Preset from 200 kPa to 1,000 kPa  $\pm$  3% throughout test.

**Minimum height of sample:** 40 mm.

**Ram Travel Speed:** adjustable, factory setting: 10 mm per second

**Angle of Gyration:** adjustable from  $0.5^\circ$  to  $2.0^\circ$ ,  $\pm 0.2^\circ$  (factory setting:  $1.25^\circ$ )

**Gyratory cycle:** 0-999. Height of specimen continuously measured during test to within  $\pm 0.1$  mm accuracy

**Rate of Gyration:** 30.0 rpm  $\pm$  0.5 rpm, constant

**Automated Shutoff:** Preset specimen height,  $N_{max}$ , or numbered of gyrations.

**Mold Construction:** steel, minimum Rockwell hardness of C 48; inside surface finish of  $1.6 \mu\text{m}$

Communications: RS-232 port. Mold Height: 250 mm. Mold Wall Thickness: 9.5 mm minimum.

**POWER SUPPLY:** 220 V, 50 Hz, single phase, 3500 W

**DIMENSIONS:** 536 x 711 x 1600 (h) mm.

**MACHINE WEIGHT:** 250 kg.

**PACKED WEIGHT:** 440 kg.

**ACCESSORIES AND SPARE PARTS:**

**B 100/1** 150 mm diameter mould

**B 100/11** Base plate for B 100/1

**B 100/12** Upper plate for B 100/1

**B 100/13** Filter paper diameter 150 mm (500 pieces)

**B 100/2** 100 mm diameter mould

**B 100/21** Base plate for B 100/2

**B 100/22** Upper plate for B 100/2

**B 100/23** Filter paper diameter 100 mm (500 pieces)

**B 100/1F** Perforated mould complete with base plate

**B 100/3** Shear strength measurement equipment  
Only available for 150 mm diameter moulds

**THERMOSTATIC WATER BATH****(5.5 litre capacity)****B 554**

Thermostatic water bath twin wall of 18/08 stainless steel without seams. Insulation is provided by fibreglass.

Steel cover.

Temperature: from ambient to 120°C (accuracy  $\pm 1.5^\circ\text{C}$ ).

Capacity 5.5 litre. Inside tank diameter 240 x 150 (h) mm.

Protection rating IP 43.

**POWER SUPPLY:** 230 V, 50/60 Hz, 1 ph, 1000 W

**DIMENSIONS:** diameter 305 x 260 (h) mm.

**WEIGHT:** 5 kg.

**B 554****AIR PERMEABILITY APPARATUS****B 096**

Used for in-situ determination of air permeability of bituminous mixtures. The apparatus consists of a metal cylinder fitted with a vacuum gauge with relevant valve and coupling for tube connection to the vacuum pump. The air permeability apparatus is sealed to the blanket surface with putty; a vacuum of 60 mm/Hg is created by means of the vacuum pump, then the valve is closed and the pump stopped. After 3 minutes it is possible to check how far the the internal pressure is increased: if the value is between 60 and 40 mm/Hg, the air permeability can be considered as satisfactory.

**DIMENSIONS:** diameter 190 x 500 mm.

**WEIGHT:** 5 kg.

Accessories:

**V 899** VACUUM PUMP (66.6 litres/minute)

Small-sized, it is particularly suitable for laboratory use.

Manometer with vacuum indication.

Max. vacuum 1 Torr.

**POWER SUPPLY:** 220 V, 50 Hz, single phase, 0.30 Kw

**DIMENSIONS:** 350 x 450 x 280 mm.

**WEIGHT:** approx. 13 kg.

**V 899****B 096**

**V 793** Rubber tubing: 2 m, dia. 6-9 mm



### 3.1.1 BITUMINOUS MIXTURES



B 512



T 644/KK

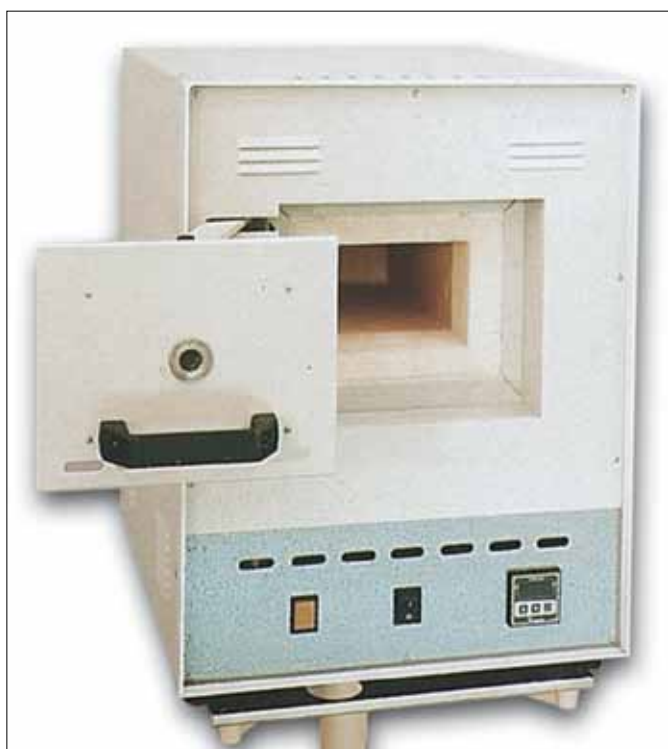

ES 185

### TECNOTEST

#### P.R.D. MOULD

##### (Percentage Refusal Density)

B 512

---

 EN 12697-32 EN 12697-10 EN 12697-9
 

---

Steel made. The mould is split vertically.  
The base is complete with quick clamping devices.

**DIMENSIONS:** diameter 152 x 170 mm.

**WEIGHT:** 15 kg.

Details of vibration hammer (T 644/KK) on page 22 (section 2.1.2).

### MUFFLE FURNACE: 1100°C

Digital temperature display.

Ceramic fiber heat insulation, sliding door for easy and safe access to the inside chamber.

Shielded Kanthal resistors for temperatures up to 1100°C.

**ES 185** Inner dimensions: 210 x 320 x 145 (h) mm  
Outer dimensions: 500 x 650 x 650 (h) mm  
Power supply: 220 V, 50 Hz, single phase, 3900 W.  
Weight: 60 kg

**ES 185/1** Inner dimensions: 145 x 250 x 100 (h) mm  
Outer dimensions: 400 x 580 x 140 (h) mm  
Power supply: 220 V, 50 Hz, single phase, 2300 W.  
Weight: 30 kg

### MUFFLE FURNACE: 1200°C

Identical to the model ES 185/1 but to 1200°C

**ES 184** Inner dimensions: 145 x 250 x 100 (h) mm  
Outer dimensions: 500 x 650 x 650 (h) mm  
Power supply: 220 V, 50 Hz, single phase, 2600 W.  
Weight: 70 kg

#### ACCESSORY:

**ES 185/T** Weekly timer

## BITUMEN EXTRACTION

ASTM D 2172 AASHTO T 164 CNR 38 EN 12697-1 EN 12697-2

## ELECTRIC CENTRIFUGE

This instrument uses non-flammable trichloroethylene for the cold extraction of bitumen so that its percentage can be calculated. It consists of a rotating bowl protected by a removable cover, a steel structure and a variable speed driving unit (electric induction motor, 3000 rpm).

Capacity of bowl: 1500 g - 3000 g of mixture depending on the model. The centrifuge's electronic control unit, which has an automatic braking system, is housed in a separate case and safety device.

**The motor is flameproof.**

Supplied with 50 filter papers.

### **CENTRIFUGE 1500 g OF MIXTURE**

**B 536**

**POWER SUPPLY:** 220 V, 50 Hz, single phase, 400 W

**DIMENSIONS:** 450 x 410 x 590 (h) mm.

**WEIGHT:** 50 kg.

### **CENTRIFUGE 3000 g OF MIXTURE**

**B 536/V2**

**POWER SUPPLY:** 220 V, 50 Hz, single phase, 600 W

**DIMENSIONS:** 500 x 500 x 550 (h) mm.

**WEIGHT:** 60 kg.

### **ACCESSORIES AND SPARE PARTS:**

**Z 66** Trichloroethylene (10 kg) non-flammable

### **B 536/8 PAPER FILTER DISKS**

Diameter 247 mm, central hole dia. 188 mm. For B 536. Pack of 50.

### **B 536/V8 PAPER FILTER DISKS**

Diameter 320 mm, central hole dia. 247 mm  
For B 536/V2. Pack of 50.

**N.B.:** IF QUANTITY OF FILLER SEPARATED DURING THE PROCESS MUST BE EVALUATED, THE LIQUID EXTRACTED MUST BE CENTRIFUGED USING ANOTHER MACHINE (B 537)



**B 536**



**B 536/8**

**B 536/V8**



**B 536/V2**

## 3.1.1 BITUMINOUS MIXTURES

## TECNOTEST



B 535/1



B 535/4

## HOT EXTRACTION

### WIRE MESH FILTER METHOD

ASTM D 2172 AASHTO T 164

#### HOT EXTRACTION (REFLUX METHOD)

**(1000 g of material)**

**B 535/1**

Two 500 g capacity stainless steel wire mesh cones.  
Pyrex receptacle jar. Metal mesh cone support frame.  
Water condenser lid with inlet/outlet nozzles.  
Supplied with 100 filter papers (diameter 320 mm).  
Electric hot plate for heating.

**POWER SUPPLY:** 220-240 V, 50 Hz, single phase, 1500 W

**DIMENSIONS:** 300 x 300 x 500 (h) mm.

**WEIGHT:** 7 kg.

#### SPARE PARTS:

**B 535/1F** Box of 100 filter papers. (dia. 320 mm)

**B 535/1V** Pyrex receptacle jar, dia. 170 x 350 (h) mm

#### HOT EXTRACTOR (REFLUX METHOD)

**(4000 g of material)**

**B 535/4**

Similar to B 535/1 but with two 2000 g wire mesh cones.  
Supplied with 100 filter papers (diameter 400 mm).  
Electric hot plate for heating.

**POWER SUPPLY:** 220-240 V, 50 Hz, single phase, 1500 W

**DIMENSIONS:** 300 x 300 x 600 (h) mm.

**WEIGHT:** 9 kg.

#### SPARE PARTS:

**B 535/4F** Box of 100 filter papers. (dia. 400 mm)

**B 535/4V** Pyrex receptacle jar, dia. 300 x 500 mm

CNR 38 DIN 1996 EN 12697-1

This apparatus consists of a pyrex jar with tap, a 200 Mesh stainless steel wire basket, a condenser head with water inlet/outlet nozzles. The basket can contain samples between 2000 and 3000 g.

Gas or electric heating is possible.

**DIMENSIONS:** diameter 340 x 320 mm.

**WEIGHT:** 5 kg.

<b>B 535/A</b>	EXTRACTOR WITH PYREX JAR Complete with tap - 200 mesh wire basket
<b>B 535/B</b>	EXTRACTOR WITH PYREX JAR Without tap - 200 mesh wire basket
<b>B 535/D</b>	Extractor with pyrex jar complete with tap 230 mesh wire basket
<b>B 535/E</b>	Extractor with pyrex jar complete with tap 230 mesh wire basket

**SPARE PARTS:**

<b>B 535/C</b>	200 Mesh wire basket
<b>B 535/F</b>	230 Mesh wire basket
<b>B 535/R</b>	Pyrex jar with tap
<b>B 535/S</b>	Pyrex jar without tap
<b>B 535/T</b>	Refrigerating cover

**FOR HEATING:**

<b>ES 180/02</b>	ELECTRIC HOT PLATE Diameter: 180 mm Power supply 220 V, 50 Hz, single phase, 500 W
------------------	--



**B 535/A**  
**ES 180/02**



**B 535/B**  
**ES 180/02**

**STEADY FLOW CENTRIFUGE**

**B 537**

ASTM D 1856 EN 12697-1

This apparatus enables the separation of the filler contained in the bitumen/trichloroethylene solution.

The bitumen/solvent/filler mixture is poured into the rotating beaker and the filler is deposited as the bitumen and solvent are drained off.

The rotation speed is 11,000 rpm.

The apparatus can also be used with conglomerates that have been coarsely dissolved by immersion in solvent.

Two sieves (Mesh 100 and 230), to be placed inside the funnel for complete separation, are supplied.

**POWER SUPPLY:** 220 V, 50 Hz, single phase, 0.37 kW

**DIMENSIONS:** 460 x 500 x 900 (h) mm.

**WEIGHT:** 60 kg.

**SPARE PART:**

<b>B 537/P</b>	Aluminium cup
----------------	---------------



**B 537**



### 3.1.1 BITUMINOUS MIXTURES



B 560

#### TECNOTEST

#### “ABSON METHOD” BITUMEN RECOVERY SET B 560

ASTM D 1856 CNR 133

The purpose of this test is the recovery of the binder from the binder/solvent solution without causing any change to the chemical-physical properties of the bitumen.

The set consists of:

- electrical heater (150 W) for 250 ml flasks
- two 250 ml flasks (one for distillation, one for collection)
- condenser with water cooling jacket
- glass tube to connect flask to condenser
- air tube with bulb and six holes
- rubber tube, with tap, for air tube/flowmeter connection
- gas flowmeter: up to 1000 ml/min
- thermometer, from -2° to +300°C

POWER SUPPLY: 220 V, 50 Hz, single phase.

WEIGHT: 8 kg.

#### BITUMEN RECOVERY SET

##### WITHOUT HEATER

**B 560/S**

Identical to B 560 but supplied without heater.

##### SPARE PARTS:

<b>B 560/V</b>	Kit of glassware for B 560
<b>B 550/7</b>	Thermometer (ASTM 7 C) -2° +300°C
<b>D 176</b>	Electric Heater



B 562

#### SOLVENT DISTILLER

**B 562**

This unit has been designed to recover non-flammable solvents, via a heat/condensation process, and consists of two stainless steel chambers.

The first one is for collecting the dirty solvent via a funnel and sieve device for subsequent distilling while the second one is for recovering the cleaned solvent.

A thermostat automatically interrupts heating process of first reservoir once distillation has been completed.

The apparatus is made entirely in stainless steel.

Max. temperature 150°C. Capacity: 10 l/h.

Capacity of distillation and collecting reservoir: 6 + 6 l.

POWER SUPPLY: 220 V, 50 Hz, single phase, 1200 W.

DIMENSIONS: 360 x 400 x 650 (h) mm with funnel.

WEIGHT: 17 kg.

##### SPARE PARTS:

B 562/T	Level indicator tube
---------	----------------------

**AUTOMATIC ASPHALT****BINDER ANALYSER****B 536/A**

EN 12697-39

This apparatus combines a sophisticated furnace and weighing system to continuously measure weight loss during combustion, then automatically calculate binder content at the end of the test. Considering the high temperatures involved (the furnace may reach a temperature of 750° C) the apparatus is equipped with suitable safety systems to ensure that the furnace door is kept shut during the test and that the heating elements are deactivated any time the door is opened.

Analysis can be made on a sample of maximum 4.5 kg and most tests are completed in 30 to 45 minutes.

An independently controlled afterburner with exhaust fan and vent reduces emissions so low that no aspiration hood is needed. An RS 232 serial port allows the apparatus to be connected to an external optional balance.

A large, easy-to-read, back-lit digital display updates all data in real-time.

At the end of the test an alarm sounds, the door is unlocked and all the results are printed: the printer may also be programmed to print data at minute intervals while test is in progress.

The apparatus is supplied complete with:

- 1 digital balance 8100 g (0.1 g)
- 2 sample basket assemblies with lid and support frame
- 1 metal handle for loading baskets in furnace
- 1 metal safety cage for containing baskets for cooling after extraction from furnace

**POWER SUPPLY:** 220 V 50 Hz 1ph, 8000 W.

**DIMENSIONS:** 600 x 750 x 1160 (h) mm.

**CHAMBER DIMENSIONS:** 220 x 350 x 450 (h) mm.

**WEIGHT:** 120 kg (approx.).

**N.B.: Support bench must be ordered apart**

**Accessory:**

**B536/B20** Support bench for B 536/A

**B 536/A**

### 3.1.1 BITUMINOUS MIXTURES

#### TECNOTEST

#### BINDER ANALYSIS APPARATUS

##### IGNITION METHOD

**B 536/E**



**B 536/E**

This apparatus works by the ignition method.

Analysis is performed on a sample weighing approx. 4 kg at a temperature of 540° C and in most cases the test lasts 30-45 minutes.

The furnace can reach a temperature of 1000° C, being insulated with refractory bricks capable of resisting temperatures up to 1260° C maximum.

A timer enables a pre-heating cycle to be set up automatically for next-day use.

Generally speaking, working temperature is reached in approximately 25-30 minutes. The furnace door has an automatic closure device for safety.

There is no need for an aspiration hood with this apparatus. Heating elements are easily accessible to facilitate replacement if necessary.

The unit is supplied complete with:

- 2 support trays, sample baskets and lids
- 1 metal fork for introducing and removing trays from furnace
- 1 container for storage of buckets after removal from furnace

**POWER SUPPLY:** 380V, 50 Hz, 3 ph, 7500 Watts.

**INNER DIMENSIONS:** 1092 x 762 x 1092 (h) mm.

**OUTER DIMENSIONS:** 533 x 535 x 229 (h) mm.

**WEIGHT:** 220 kg.

##### SPARES:

<b>B 536/E1</b>	Sample basket
<b>B 536/E3</b>	Box of 12 spare filters



**B 534**

#### KUMAGAWA EXTRACTOR

**B 534**

Used for hot extraction of bitumen.

The apparatus includes: electric heater, box of 25 filters 75 x 250 mm, glass balloon 1000 ml, tripod, refrigeration tube and 10 ml raccord tube with 1/10 divisions and tap.

**POWER SUPPLY:** 220 V, 50 Hz, single phase, 400 W.

##### SPARE PARTS:

<b>B 534/F</b>	Box of 25 filters 75 x 250 mm
<b>B 534/V</b>	Kit of glassware for B 534
<b>D 176/2</b>	Electric heater



**B 533**

#### MIXER WITH HEATER

**B 533**

Necessary for preparing mixes to make Marshall specimens. May also be used for preparing mortar or soil specimens.

It has a capacity of 5 litres and 4 mixing speeds while the bowl is supplied complete with electric heater fitted to special frame. Electric system for heating device with temperature regulation is separate from that of the mixer.

**POWER SUPPLY:** 220 V, 50 Hz, single phase, 800 W

**DIMENSIONS:** 350 X 400 x 600 (h) mm.

**WEIGHT:** 25 kg.

## PLANETARY MIXERS FOR ASPHALT

EN 12697-35

“INOXTEC” range of planetary mixers with structure and bowl built entirely in stainless steel.

The mixing bowl is supplied, provided with special couplings for rapid attachment to mixer.

The beater, in special nickel-plated steel for use with bituminous mixtures (supplied), can be quickly and easily removed and repositioned. Double safety devices as required by “CE” directives: on the bowl lowering assembly and on the upper safety guard. Synchronized rotation and revolution movements (6 working speeds).

### **5 LITRE PLANETARY MIXER** **B 205/5** **(heater not included)**

Planetary speeds: 25 - 32 - 39 - 49 - 53 - 60 rpm (clockwise rotation).

Beater speeds: 55 - 71 - 86 - 102 - 117 - 132 rpm (anticlockwise rotation).

POWER SUPPLY: 220 V, 50 Hz, 1ph, 400 Watts

DIMENSIONS: 390 x 500 x 690 (h) mm.

WEIGHT: 35 kg.

### **ELECTRIC HEATING DEVICE WITH** **B 205/H** **STAINLESS STEEL LIFTER FOR B 205/5**

POWER SUPPLY: 220 V, 50 Hz, 1ph, 600 Watts

DIMENSIONS: 270 x 350 x 240 (h) mm.

WEIGHT: 5.5 kg.

#### **ACCESSORIES AND SPARE PARTS:**

**B 205/B** Beater FOR ASPHALT in special nickel-plated steel for B 205/5

**C 371/B** 5 litre stainless steel bowl for B 205/5



**B 205/5**



**B 205/5 - B 205/H**



**B 205/B**



**B 205/H**



### 3.1.1 BITUMINOUS MIXTURES

TECNOTEST



B 205/E



B 205/C

B 205/D



B 205/Z

#### 20 LITRE PLANETARY MIXER (heater not included)

B 205/20

Complete with bowl B 205/P and beater B 205/Z.

Planetary speeds: 25 - 32 - 39 - 46 - 53 - 60 rpm (clockwise rotation)

Beater speeds: 64 - 82 - 100 - 118 - 136 - 154 rpm (anticlockwise rotation)

POWER SUPPLY: 220 V, 50 Hz, 1ph, 750 Watts

DIMENSIONS: 550 x 580 x 850 (h) mm

WEIGHT: 75 kg

#### ELECTRIC HEATING DEVICE WITH HEATING ELEMENT FOR B 205/20 control panel with heat regulator

B 205/E

POWER SUPPLY: 220 V, 50 Hz, 1ph, 2100 Watts

DIMENSIONS: 250 x 450 x 130 (h) mm

WEIGHT: 7 kg

#### ACCESSORIES AND SPARE PARTS:

**B 205/Z** Beater FOR ASPHALT  
in special nickel-plated steel for B 205/20.  
It consists in: B 205/N (beater),  
B 205/NR (connecting device)

**B 205/C** Spiral steel beater for B 205/T

**B 205/D** Flat stainless steel beater for B 205/T

**B 205/P** 20 litre bowl in reinforced stainless steel  
for B 205/20. Flat bottom

**B 205/T** 20 litre bowl in reinforced stainless steel  
for B 205/20. Round bottom



B 205/20

**PENETROMETER****B 531/1**

ASTM D 5 EN 1426 BS 2000 AASHTO T 49 CNR 24

Micrometric vertical adjustment.

Light-alloy base with levelling screws.

Stainless steel calibrated spindle (weight 47.5 g) with friction-free movement. Stop and release button.

Dial with 360 divisions corresponding to 0.1 mm penetration steps.

Automatic zeroing and relevant micrometric screw.

The instrument is secured to a cast light-alloy base and slides on the base's upright.

Complete with blocking device and device for the micrometric adjustment of displacements.

Suitable for bitumen (needle) and grease (cone).

**Supplied without accessories.**

**DIMENSIONS:** 290 x 270 x 530 (h) mm.

**WEIGHT:** 5.5 kg

**B 531/1****SEMI-AUTOMATIC PENETROMETER****B 531/3**

Same as B 531/1 but with an electro-magnetic system and timer in the base for the automatic stop and release of the spindle every 5 seconds.

**POWER SUPPLY:** 220-240 V, 50 Hz, single phase.

**ACCESSORIES AND SPARE PARTS:**

<b>B 531/B</b>	Container diameter 3" x 2.5" (brass)
<b>B 531/G</b>	Container diameter 70 x 45 mm (brass)
<b>B 531/P</b>	Container diameter 55 x 35 mm (brass)
<b>B 531/PP</b>	Set of brass weights (50 and 100 g.)
<b>B 531/PA</b>	Kit of 10 containers diameter 55 x 35 mm (aluminium)
<b>B 531/A</b>	Standard needle for penetrometer
<b>B 531/AV</b>	NAMAS verified needle
<b>B 531/T</b>	Thermometer (23°-27°C)
<b>B 531/C</b>	Penetration cone (ASTM D 217) Made of brass with stainless steel point Weight: 102.5 g

**B 531/C****DURIEZ COMPRESSION TEST SET  
for dia. 80 mm specimens****B 680**

Used for the determination of the physical and mechanical properties of bituminous mixtures. The set consists of a metal mould with base and compression plunger and a support for sample extraction from mould. A compression machine of suitable capacity is required for the preparation of the specimen and subsequent compression test.

**WEIGHT:** 15 kg.

**B 680**

### 3.1.1 BITUMINOUS MIXTURES

### TECNOTEST

#### HIGH-PRECISION THERMOSTATIC BATH

**B 531/V**

ASTM D 5 EN 1426

For penetration tests on bituminous materials.  
 The bath (10 litres approx.) contains water at the testing temperature ( $25^{\circ}\text{C} \pm 0.1^{\circ}\text{C}$ ) for the correct execution of the test. The apparatus comprises a stainless steel bath complete with lid. Fitted with water circulation pump, bowl (stainless steel) with cooling coil and heating resistance.  
 The group is complete with tubes, connections and transfer cup with cooling coil.  
 Temperature regulation from room temperature to  $60^{\circ}\text{C}$ . Heating resistance.  
 Control panel; digital setting and reading of temperature.

**POWER SUPPLY:** 220 V, 50 Hz, single phase, 325 W

**DIMENSIONS:** 300 x 280 x 600 (h) mm.

**WEIGHT:** 10 kg.

**SPARE PARTS:**
**B 531/Z1** Pyrex transfer cup

**B 531/ZR** Bowl (Stainless steel) with cooling coil

**B 531/V**

#### AUTOMATIC DIGITAL PENETROMETER

**B 532**

ASTM D 5 AASHTO T 49 EN 1426

A microprocessor-based compact instrument using the latest technologies and programming tools: motorized mobile head, digital keyboard, LCD alpha-numeric display.

- The interactive software allows the penetration time as well as the soak time to be set and programmed between 0 and 999 seconds
- The head can be vertically moved at 4 different speeds with a precision of between 1/10 mm and 1/100 mm
- 4 mobile head positions can be memorized in order to shorten approaches and levelling attempts.
- Limit parameters can also be entered.
- If test falls out of these preset limits both a visible and audible signals are activate
- During the test, depth penetration is permanently displayed both in units and tenth of units (0.01 mm)
- Optoelectronic detection of depth penetration with an automated approach and a levelling system for conductive samples
- The instrument is made of an anodized aluminium baseplate with levelling screws and spirit level, sample containers centering guide, magnifying lens and low voltage illuminator mounted on flexible arms
- An RS 232 connection to computer and a ticket printer are also included

SUPPLIED WITHOUT ACCESSORIES

**POWER SUPPLY:** 220-240 V, 50-60 Hz, single phase

**DIMENSIONS:** 260 x 320 x 540 (h) mm

**WEIGHT:** 23 Kg

**KIT OF ACCESSORIES**
**B 532/A**

2.5 g needle with support, a 50-gram weight and 2 containers.

**B 532**

## ELECTRIC WATER BATHS

Max. temperature 100°C. Thermostatic control.  
Made of stainless steel with double-wall and cover.  
Electric heating with immersion heaters.

### 20 LITRE CAPACITY

**B 539**

POWER SUPPLY: 220 V, 50 Hz, single phase, 800 W  
INTERNAL DIMENSIONS: 280 x 280 x 260 (h) mm.  
OVERALL DIMENSIONS: 430 x 340 x 370 (h) mm.  
WEIGHT: 10 kg.



**B 539**

**B 539/E**

### 13 LITRE CAPACITY

**B 539/E**

POWER SUPPLY: 220 V, 50 Hz, single phase, 500 W  
INTERNAL DIMENSIONS: 280 x 280 x 170 (h) mm.  
OVERALL DIMENSIONS: 430 x 340 x 270 (h) mm.  
WEIGHT: 9 kg.

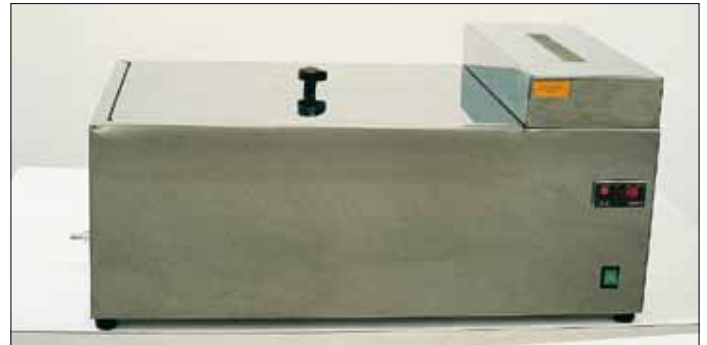

**B 539/P**

### 40 LITRE CAPACITY

**B 539/P**

Fitted with digital thermometer for thermo-regulation and motorized stirrer.  
Temperature: from ambient to 100°C ± 1°C

POWER SUPPLY: 220 V, 50 Hz, single phase, 1200 W  
INTERNAL DIMENSIONS: 550 x 360 x 200 (h) mm.  
OVERALL DIMENSIONS: 830 x 440 x 500 (h) mm.  
WEIGHT: 30 kg.



**B 539/S**

### 40 LITRE CAPACITY - REFRIGERATED

**B 539/S**

Fitted with digital thermometer for thermo-regulation and motorized stirrer. Refrigerating copper coil which is located on the bottom of the tank.  
Temperature: from ambient to 100°C ± 1°C

POWER SUPPLY: 220 V, 50 Hz, single phase, 1200 W  
INTERNAL DIMENSIONS: 550 x 360 x 200 (h) mm.  
OVERALL DIMENSIONS: 830 x 440 x 500 (h) mm.  
WEIGHT: 30 kg.

### 40 LITRE CAPACITY - REFRIGERATOR UNIT

**B 539/F**

Equipped with a 0.25 hp refrigerator unit located under the tank. Condenser, ventilating fan and switch for the refrigerator.  
Temperature: from 5° to 100°C ± 1°C.

POWER SUPPLY: 220 V, 50 Hz, single phase, 1650 W  
INTERNAL DIMENSIONS: 550 x 360 x 200 (h) mm.  
OVERALL DIMENSIONS: 830 x 440 x 850 (h) mm.  
WEIGHT: 40 kg.



**B 539/F**



### 3.1.2 BITUMEN AND EMULSIONS

TECNOTEST



B 538



B 538/B  
B 538/B1 x 2



B 538/C  
B 531/P x 8



B 538/V

## ASPHALT OVEN WITH ROTATING PLATE

ASTM D 6 ASTM D 1754 AASHTO T 179 CNR 50 EN 12607-2

Double wall construction, inside and outside in stainless steel. Double wall door incorporating tempered crystal window. Electric heating with resistors located on the bottom of the oven. Protective double bottom.

Digital setting and reading with thermostatic control between 50° and 180°C.

Internal rotating plate (6 rpm) driven by gear reduction unit.

**POWER SUPPLY:** 220 V, 50 Hz, single phase, 600 W.

**INTERNAL DIMENSIONS:** 330 x 330 x 330 (h) mm.

**EXTERNAL DIMENSIONS:** 460 x 450 x 705 (h) mm.

**WEIGHT:** 30 kg.

### THE OVEN IS SUPPLIED IN TWO VERSIONS:

**B 538** For "WEIGHT LOSS" test (ASTM D 6) with 9 containers dia. 55 x 35 mm and rotating support plate

**B 538/S** For "THIN FILM" test (ASTM D 1754) with 2 containers dia. 140 x 9.5 mm and rotating support plate

## ROLLING THIN FILM OVEN

This oven has an air circulation device and a maximum working temperature of up to 180°C.

The control box, fitted on the left hand side includes:

- electronic temperature regulator and digital read-out with double setting level
  - hydraulic expansion safety device - general switch
  - flowmeter to measure air flow, range 0-600 litres/hour
- Complete with rotating shelf. Without Pyrex containers.

**POWER SUPPLY:** 220 V, 50 Hz, single phase

**DIMENSIONS:** 600 x 600 x 900 (h) mm.

**WEIGHT:** 45 kg.

**B 538/T** For R.T.F.O. test (ASTM D2872 - AASHTO T 240) 1900 W

**B 538/V** For R.T.F.O. test (EN 12607-1) 1600 W

### ACCESSORIES:

**B 538/A** Glass control thermometer (ASTM 13 C) 155° to +170°C (0.5°C divisions)

**B 538/B** Rotating shelf (without containers) for "Thin Film" test (B 538/S)

**B 538/B1** Container dia. 140 x 9.5 mm

**B 538/C** Rotating shelf (without containers) for "Weight Loss" test (B 538)

**B 531/P** Container dia. 55 x 35 mm

**B 538/T1** Pyrex container for B 538/T and B 538/V dia. 64 x 140 (h) mm - 32 mm hole (8 pcs needed for RTFO test)

**B 531/PA** Kit of 10 containers diam. 55 x 35 mm (aluminium)

**EMULSIFIED ASPHALT DISTILLATION APPARATUS B 550**

ASTM D 244 AASHTO T 59 CNR 100 EN 1431

Used to examine asphalt emulsions mainly composed of semisolid or liquid asphaltic base, water and emulsifying agent. The apparatus consists of:

- aluminium alloy still with ring burner
- glass connecting tube with water-cooled condenser
- graduated cylinder of 100 ml capacity
- support stands and holders
- two thermometers range  $-2$  to  $+300^{\circ}\text{C}$

WEIGHT: 9 kg approx



B 550

**BREAKING POINT-FRAASS METHOD B 552/ST**

CNR 43 DIN 51012 EN 12593

To determine the breaking point of cold bitumen.

The apparatus consists of:

- two sliding concentric tubes made of resin, the ends of which have the jaws for the specimen and the flexure equipment. A crank tightens the jaws to 3.5 mm.
- special spring steel plate.
- cooling equipment consisting of three concentric glass containers and accessories.

DIMENSIONS: diameter 150 x 350 (h) mm.

WEIGHT: 3 kg.

**ACCESSORIES:**

<b>B 552/P</b>	Kit of 10 spring steel platens
<b>B 552/T</b>	Thermometer $-38^{\circ}\text{C}$ to $+30^{\circ}\text{C}$ ( $0.5^{\circ}\text{C}$ divisions)



B 552/ST

**APPARATUS FOR DETERMINING PARTICLE CHARGE OF EMULSIFIED ASPHALT B 521**

ASTM D 244 CNR 99 EN 1430

This apparatus (used to identify cationic emulsions) comprises a milliamperometer, a variable resistor, two stainless steel electrodes measuring 1 x 4 in. each and a 250 cc beaker. Base includes rod complete with test clips.

POWER SUPPLY: 230 V, 50-60 Hz, 1ph.

DIMENSIONS: 150 x 210 x 300 (h) mm.

WEIGHT: 3 kg.

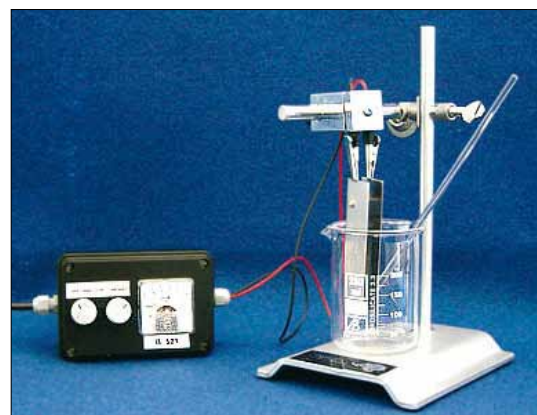

B 521

## 3.1.2 BITUMEN AND EMULSIONS

## TECNOTEST



B 548/ST

**“CUT-BACK” ELECTRIC DISTILLER**

for fluid bitumen

B 548/ST

ASTM D 402 AASHTO T 78 AFNOR T 66-003

This equipment consists of:

- small electric oven with auto transformer
- 117 mm diameter chimney with lid in two parts
- 500 cc pyrex flask
- cooling jacket (250 mm long) with inner tube and curved extension
- 100 ml glass cylinder
- two support stands with rods and clamps

POWER SUPPLY: 220 V, 50 Hz, single phase, 600 W.

DIMENSIONS: 800 x 300 x 650 (h) mm.

WEIGHT: 13 kg.

**ACCESSORIES AND SPARE PARTS:**

<b>B 548/V</b>	Kit of glassware for B 548/ST
<b>B 548/T</b>	Thermometer -2° +400°C (ASTM 8C)

**TEST APPARATUS FOR****“RESIDUE OF SPECIFIED PENETRATION”**

B 705

This apparatus (according to ASTM D 243) consists of a tripod with support rod and pliers, a bunsen burner and wire gauze, an air bath with specimen container and a glass ASTM 11 C thermometer (range -6° +400°C). In practice, the test consists in the evaporation of the asphalt's volatile components until a specific penetration value is reached.

DIMENSIONS: 300 x 300 x 1000 (h) mm.

WEIGHT: 3 kg.

**SPARE PARTS:**

<b>B 705/2</b>	Air bath
<b>B 526/1</b>	Glass thermometer
<b>B 531/G</b>	Sample container dia. 70 x 45 mm



B 705

**“CLEVELAND” APPARATUS****B 526**

EN 22592 ASTM D 92 BS 4689 AASHTO T 48 CNR 72

To determine the “open-cup”, flash and fire points of oil products with a flash point above 80°C. Calibrated cup.  
Gas or liquid gas lighting device above the cup.  
Electric thermostatic heater.

**POWER SUPPLY:** 220-240 V, 50 Hz, single phase, 550 W**DIMENSIONS:** 220 x 220 x 450 (h) mm.**WEIGHT:** 11 kg.

**B 526/1** THERMOMETER -6° to +400°C (2°C divisions)  
ASTM 11 C

**B 526/C** TEST CUP (spare)

**“BACON BOMB” SAMPLER****B 553**

ASTM D 140 AASHTO T 40 CNR 81 CNR 98

For taking petroleum samples from the bottom of tanks. Made of brass. Special valve for automatic opening and closure.

**DIMENSIONS:** 85 x 300 mm.**WEIGHT:** 2 kg.**WATER CONTENT IN BITUMEN****B 549**

ASTM D 95 ASTM D 244 AASHTO T 55 AASHTO T 59 CNR 101

For the determination of the water content in bituminous materials by means of distillation with a volatile solvent that cannot be mixed with water (Dean and Stark method).

The apparatus consists of:

- 500 ml bowl glass distiller
- 400 mm long glass condenser (Liebig type)
- 10 ml trap glass receiver

All glassware has standardized conical joints.

Electrical heater.

**DIMENSIONS:** 200 x 200 x 1200 (h) mm.**WEIGHT:** 12 kg.**WATER CONTENT IN BITUMEN EMULSIONS****B 549/2**

EN 1428 EN 12847 ASTM D 244

Identical to the B 549, has a 25 ml glass receiver (0.1 ml graduations).

**SPARE PARTS:**

**B 549/R** Adjustable electric heater, 250 Watts  
Support pliers and rod  
220 - 240V, 50 Hz, single phase

**B 549/V** Kit of glassware for B 549

**B 549/V2** Kit of glassware for B 549/2

**B 549/25** Glass receiver: 25 ml

**B 549/10** Glass receiver: 10 ml

**GRADUATED GLASS CYLINDER****B 551**

EN 12847

For determining the settling tendency of bitumen emulsions. Graduations up to 500 cc. Closeable side tubes.

**B 526**  
**B 526/1****B 553****B 549****B 551**



## 3.1.2 BITUMEN AND EMULSIONS

## TECNOTEST



B 529/ST



B 540/ST



V 987  
V 988  
V 748/1  
V 989

**ENGLER VISCOMETER****B 529/ST**

ASTM D 1665 BS 4693 CNR 102

Brass cup, calibrated efflux capillary in stainless steel.

Double-walled thermally-insulated brass cover.

Bath with front opening.

Stick for closing the efflux capillary.

Heating with electric immersion resistances.

Cooling coil. Automatic electronic thermostatic control, with digital thermometer. Motorized stirrer guarantees the thermostatic uniformity of the heating bath.

Calibrated glass flask: 100 + 100 cc.

**POWER SUPPLY:** 220 V, 50 Hz, single phase, 400 W.

**DIMENSIONS:** 300 x 260 x 500 (h) mm.

**WEIGHT:** 7 kg.

**ACCESSORIES AND SPARE PARTS:**

**B 529/2** Set of three Engler thermometers  
ASTM 23 C (+18 +28)  
ASTM 24 C (+39 +54)  
ASTM 25 C (+95 +105)

**B 529/3** Glass flask: 100 + 100 cc

**B 529/4** Glass flask: 200 cc

**REDWOOD VISCOMETER BRTA****B 540/ST**

EN 12846

Calibrated brass cup for oil. Orifice diameter 4 mm.

Rod with stopping ball. Front-opening water bath with cover and thermometer slot. Electric heating.

Digital thermo-regulation and motorized stirring system.

100 cc graduated glass cylinder. 100 cc graduated glass flask.

**POWER SUPPLY:** 220 V, 50 Hz, single phase, 400 W.

**DIMENSIONS:** 300 x 260 x 500 (h) mm

**WEIGHT:** 7 kg.

**ACCESSORIES AND SPARE PARTS:**

**B 540/3** Cup with orifice. Dia. 10 mm.  
Complete with stopper

**B 540/4** Cup with orifice. Dia. 4 mm.  
Complete with stopper

**B 540/1** 100 ml flask

**B 540/2** Thermometer 0° to +45°C (IP 8 C)

**B 540/D** Go/no go gauge: 4 mm

**B 540/F** Go/no go gauge: 10 mm

**DEGREE OF SOLUBILITY OF BITUMINOUS BINDERS**

ASTM D 2042 EN 12592

**V 748/1** Glass filter flask: 500 cc

**V 987** GOOCH CRUCIBLE (porcelain)  
Perforated bottom Ø 25 mm. Ø 41 mm x 43 (h)

**V 988** FUNNEL FOR GOOCH CRUCIBLE (V 987)

**V 989** Fiberglass filters dia. 25 mm  
Box of 100 pcs

## KINEMATIC VISCOSITY OF ASPHALT

ASTM D 2170 AASHTO T 201 EN 12595

### THERMOSTATIC WATER BATH

**FOR VISCOMETERS: MAX TEMP. 135°C** **B 505**

The temperature, from room temperature to 135°C, remains constant within  $\pm 0.1^\circ\text{C}$ .

Electric stirrer, electric heater and cooling (COIL) system.

Digital read-out and regulation of temperature.

Safety device for temperature and water level with alarms.

Bath (Pyrex glass, 19 litres capacity) with external protection in plexiglass. Support base with housing seats.

Capacity: five viscometers to be ordered separately according to viscosity.

**POWER SUPPLY:** 220 V, 50 Hz, single phase, 1700 Watts

**DIMENSIONS:** 300 x 300 x 500 (h) mm.

**WEIGHT:** 12 kg.



**B 505**

## CANNON-FENSKÉ VISCOMETERS

With Tecnotest certificate of calibration (at 40°C - 104°F) and constant (K) indication.

Opaque Liquids	Transparent Liquids	Series	K (nominal)	cSt
B 500/A	B 500/AT	25	0.002	0.5 - 2
B 500/B	B 500/BT	50	0.004	0.8 - 4
B 500/C	B 500/CT	75	0.008	1.6 - 8
B 500/D	B 500/DT	100	0.015	3 - 15
B 500/E	B 500/ET	150	0.035	7 - 35
B 500/F	B 500/FT	200	0.1	20 - 100
B 500/G	B 500/GT	300	0.25	50 - 250
B 500/H	B 500/HT	350	0.5	100 - 500
B 500/I	B 500/IT	400	1.2	240 - 1200
B 500/L	B 500/LT	450	2.5	500 - 2500
B 500/M	B 500/MT	500	8	1600 - 8000
B 500/N	B 500/NT	600	20	4000 - 20000

### 3.1.2 BITUMEN AND EMULSIONS



B 527/ST



B 528/ST



B 528/S

### TECNOTEST

#### “FLOAT TEST” APPARATUS

B 527/ST

ASTM D 139 AASHTO T 50

To determine the consistency of bituminous materials with the “float” method.

Aluminium cup of 38 g (approx.) with 11 - 12.2 mm opening. 10 g brass collar screwed onto the lower part of the cup.

Each cup is complete with 3 standard collars.

**DIMENSIONS:** 100 x 100 x 60 (h) mm.

**WEIGHT:** 0.2 kg.

#### ACCESSORY:

**B 527/T** ASTM 15 C thermometer (-2° to +80°C)

#### SAYBOLT VISCOMETER

B 528/ST

ASTM D 88 AASHTO T 72

The time required for 60 cc of liquid bitumen to flow through the orifice is measured in seconds.

The temperature of the bitumen is prescribed by the Standards. The values obtained from the test are expressed in terms of Saybolt Furol Seconds (SFS).

The apparatus consists of:

- interchangeable Universal Orifice (SUS viscosity up to 1000 sec.)
- brass oil cup with gold-plated interior with interchangeable calibrated efflux orifice in stainless steel
- front-opening stainless steel bath with cooling coil
- electric heater with electronic temperature setting (0.1°C) and digital display
- electric motor-driven stirring system for temperature uniformity
- glass flask calibrated to 60 cc

**POWER SUPPLY:** 220 V, 50 Hz, single phase, 400 W.

**DIMENSIONS:** 300 x 260 x 500 (h) mm.

**WEIGHT:** 7 kg.

#### FOUR-PLACE SAYBOLT VISCOMETER

B 528/S

Identical to B 528/ST model but designed to perform 4 tests.

**DIMENSIONS:** 750 x 260 x 500 (h) mm.

**WEIGHT:** 12 kg.

#### ACCESSORIES AND SPARE PARTS:

**B 528/20** Saybolt thermometer (57 +65°C)

**B 528/21** Saybolt thermometer (79 +87°C)

**B 528/3** 60 ml glass flask

**B 528/5** Stainless steel orifice: Universal Complete with key. Interchangeable

**B 528/7** Stainless steel orifice: Furol (SUS viscosity more than 1000 sec.) Complete with key. Interchangeable

**B 528/L** Viscometer oil. 1000 CST - 1 KG

**HUBBARD CARMICK BOTTLE****V 724**

For specific gravity determination. 25 ml capacity.  
Pyrex glass. 45 mm height, base diameter 40 mm, neck diameter 25 mm. Frosted stopper with 1 mm hole.

**PICNOMETERS, GAY-LUSSAC TYPE**

Made of glass complete with capillary vent stopper.

**V 725/T** 100 ml capacity (calibrated)

**V 726/T** 50 ml capacity (calibrated)

**V 750/1****V 724****V 725/T****V 726/T****GLASS PYCNOMETERS**

Complete with glass calibrating funnel, frosted cone (29-32).

**V 750/1** 500 ml conical pycnometer

**V 750/2** 1000 ml conical pycnometer

**V 750** 2000 ml conical pycnometer

**THEORETICAL MAX SPECIFIC GRAVITY****PYCNOMETER, 10 LITRE CAPACITY****V 777/P**

EN 12697 ASTM D 2041

Plastic made, 250 mm diameter with valve and vacuum gauge.

Accessories: see section 5.3.5 page 379

**V 793** Red rubber tubing, 5 m, Ø 8-16 mm

**V 899** Vacuum pump

**D 855/1** Electromagnetic stirrer for V 777/P

**V 791/T** PVC Rubber tubing, 2 m, Ø 6-9 mm

**V 791** Water jet suction pump

**DB 501/D** DIGITAL STOP WATCH (0.01 seconds)  
59 minutes, 59 seconds

**DB 501** PRECISION STOP WATCH (0.1 seconds)  
15 minutes, 30 seconds

**DB 501/A** PRECISION STOP WATCH (0.2 seconds)  
60 minutes, 60 seconds

**DB 501/S** TIMING DEVICE. 0 to 60 minutes  
1 minute divisions

**DB 501/SD** DIGITAL TIMING DEVICE  
0-19 hours; 0-59 minutes

**V 777/P****V 791****V 899**





B 530  
B 530/A  
B 530/B



B 530/E



ES 177  
V 780/1  
ES 178

## “BALL AND RING” APPARATUS

AASHTO T 53 AASHTO T 78 ASTM D 36 AFNOR T 66008  
BS 2000 CNR 35 EN 1427 UNI 4161

For determining the softening point.

The equipment consists of:

- a set of two balls dia. 3/8", 2 rings, 2 centering collars.
- two-gang framework to support rings, collars and balls and for thermometer insertion.
- pyrex beaker diameter 85 x 130 mm for the immersion of the frame and samples.

This equipment is available in three versions:

<b>B 530</b>	“BALL AND RING” APPARATUS With electric heater and electric stirrer to maintain a uniform water temperature. Power supply: 220 V, 50 Hz, single phase, 550 W.
<b>B 530/Z</b>	“BALL AND RING” APPARATUS Identical to B 530 but without the electric stirrer.
<b>B 530/E</b>	“BALL AND RING” APPARATUS Identical to B 530 but without the electric stirrer and without the electric heater.

### ACCESSORIES AND SPARE PARTS:

<b>B 530/A</b>	Thermometer -2 to +80°C, divisions 0.2°C, ASTM 15 C, IP 60/C
<b>B 530/B</b>	Thermometer +30 to 200°C, divisions 0.5°C, ASTM 16 C, IP 61/C
<b>B 530/113</b>	Thermometer -1 to +175°C, divisions 0.5°C, ASTM 113 C, IP 89/C
<b>B 530/3</b>	Set of two balls, two rings, two collars (ASTM - AASHTO - EN)
<b>B 530/4</b>	Set of two balls, two rings, two collars (IP)
<b>B 530/P</b>	Pyrex beaker, Ø 85 x 130 mm
<b>ES 178</b>	Bunsen burner Cast aluminium base. Air regulator. Dimensions: diameter 80 x 140 (h) mm Weight: 0.2 kg.
<b>ES 177</b>	Metal tripod. dia. 120 x 180 (h) mm
<b>V 780/1</b>	Wire gauze 16 x 16 cm
<b>V 780/2</b>	Wire gauze 20 x 20 cm

**“PENSKY-MARTENS” FLASH POINT TESTER B 522**

ASTM D 93 AASHTO T 73 EN 22719

For determining the flash point of oil products with a flash point above 50°C “in a closed cup”.

Calibrated cup, lid with double-blade motorized stirrer (100 rpm), shutter with double-flame lighting and release device, cast-iron air bath with stainless steel outer cover, gas or liquid gas lighting system of flame feed.

**POWER SUPPLY:** 220-240 V, 50 Hz, single phase, 550 W

**DIMENSIONS:** 220 x 220 x 400 (h) mm.

**WEIGHT:** 12 kg.

**ACCESSORIES AND SPARES:**

<b>B 522/1</b>	Motorized stirrer (100 rpm)
<b>B 522/2</b>	Motorized stirrer (250 rpm)
<b>B 522/C</b>	Thermometer -5° to +110°C (0.5°C divisions) ASTM 9 C
<b>B 522/D</b>	Thermometer +90° to +370°C (2°C divisions) ASTM 10 C



B 522

**DUCTILOMETER B 546**

EN 13398 ASTM D 113 AASHTO T 51 CNR 44

The ductility of bituminous materials is determined by measuring the elongation before failure of a sample subjected to tensile stress in pre-determined conditions of speed and temperature (50 mm/min.; 25° C).

The apparatus is stainless steel made.

Cooling coil, water circulating pump, thermostat ( $\pm 0.1^\circ\text{C}$ ), digital display, gear reduction unit for mould feed, manual tensile stress carriage.

Suitable for testing 3 samples simultaneously.

Electric motor: 0.25 hp.

Graduated scale.

Standard carriage stroke: 1500 mm .

Supplied without accessories (either moulds or mould plates must be ordered separately).

**POWER SUPPLY:** 220 V, 50 Hz, single phase, 850 W.

**DIMENSIONS:** 2000 x 300 x 400 (h) mm.

**WEIGHT:** 60 kg.

**REFRIGERATED DUCTILOMETER B 546/F**

Identical to the B 546 but with refrigerator unit and thermostat for temperatures from 1 to 25°C.

**POWER SUPPLY:** 220 V, 50 Hz, single phase, 1300 W

**ACCESSORIES:**

<b>B 547/A</b>	Ductility briquette mould, (brass made) (ASTM - AASHTO)
<b>B 547/C</b>	Ductility briquette mould, (brass made) (EN - CNR)
<b>B 547/B</b>	Duralumin mould plate



B 546

B 547/A  
B 547/B

### 3.1.2 BITUMEN AND EMULSIONS

#### TECNOTEST



#### DIGITAL THERMOMETER: -200 +650°C

**DB 840**

Resolution 0.1° C. Display LCD.

Accuracy ±0.05° C. Complete with DB 840/1 probe.

#### ACCESSORIES AND SPARE PARTS:

**DB 840/1** Immersion probe, dia. 3 x 230 (h) mm  
(temperature -50 + 400°C)

**DB 840/2** Air probe, dia. 4 x 230 (h) mm  
(temperature -50 + 250°C)

**DB 840/3** Contact probe, dia. 5 x 230 (h) mm  
(temperature -50 + 400°C)

**DB 840**

**DB 833**

**DB 532/T DB 237 DB 237/B**

### BIMETALLIC THERMOMETERS

Code	Temperature	Dial Ø	Stem
<b>DB 237</b>	0 + 60°C	60 mm	200 mm
<b>DB 237/2</b>	0 + 120°C	60 mm	200 mm
<b>DB 237/1</b>	0 + 200°C	60 mm	200 mm
<b>DB 237/3</b>	0 + 250°C	60 mm	200 mm
<b>DB 237/A</b>	0 + 80°C	100 mm	900 mm
<b>DB 237/B</b>	0 + 200°C	100 mm	900 mm
<b>DB 532/V</b>	- 40 + 40°C	20 mm	120 mm
<b>DB 532/B</b>	0 + 500°C	60 mm	200 mm
<b>DB 532/T</b>	0 + 250°C	20 mm	120 mm
<b>DB 532/X</b>	0 + 120°C	20 mm	120 mm

**DB 833** INFRA-RED THERMOMETER  
 Range - 33 + 500° C. Accuracy ± 2° C  
 Dimensions 200 x 100 x 50 mm  
 Weight 600 gr

#### PERMEAMETER (MPW - BELGIUM)

**B 097**

The test gives the draining time (seconds) of a fixed quantity of water passing through a bituminous mixture.

It consists of:

- Plastic (PERSPEX) graduated cylinder 100 mm dia. 500 mm length, placed in a special base.
- 20 kg weight with handles
- Neoprene ring

**DIMENSIONS:** 200 x 200 x 700 (h) mm.

**WEIGHT:** 25 kg .

**B 097**

**B 098**

#### PERMEAMETER

**B 098**

For in-situ determination of the permeability and drainage on roads and pavements.

The test is based on the same principle of the B 097.

The instrument consists of:

- Plastic (PERSPEX) graduated cylinder, 140 mm internal diameter, 390 mm height.
- 5 kg counterweight with handles

**DIMENSIONS:** 265 x 265 x 415 (h) mm.

**WEIGHT:** 8 kg.

**50 kN PLATE BEARING TEST**

TB 637

Reference Standards : C.N.R. N° 146  
S.N.V. N° 70317

This apparatus comprises :

- 100 kN single-acting hydraulic cylinder incorporating frame to house the dial gauge;
- ball seating;
- load plate having 300 mm diameter and 25 mm thick;
- counter-plate having 160 mm dia. and 25 mm thick;
- 4 extensions for cylinder stem: 2 pcs 200 mm and 1 pce 100 mm and 1 pce 50 mm long;
- 2.5 m aluminium index bar (may be divided into two parts) with adjustable supports and dial gauge bracket;
- 10 mm travel dial gauge with 0.01 graduations complete with adjustable anvil;
- minimum testing height 541 mm
- hydraulic hand pump complete with tank, valve and slow discharge device, flexible hose and quick coupling;
- twin scale (kN - N/mm<sup>2</sup>) class 0.5 manometer having 200 mm diameter and quick coupling.
- packing 860 x 440 x 370 mm (case) plus plastic tube dia. 160 x 1600 mm

**DIMENSIONS ASSEMBLED:** 2500 x 1000 x 700 (h) mm.

**WEIGHT NET:** 75 kg

**WEIGHT GROSS:** 97 kg

**50 kN PLATE BEARING TEST**

TB 637/3

Identical to the previous model but provided with three dial gauges (10 mm travel, 0.01 graduations) and relevant supports.

**100 kN PLATE BEARING TEST**

TB 637/01

Identical to TB 637 but with 100 kN capacity.

**100 kN PLATE BEARING TEST**

TB 637/03

Identical to TB 637/3 but with 100 kN capacity.

**ACCESSORIES AND SPARES:**

<b>BK 005/2R</b>	Manometer diameter 200 mm Capacity 50 kN (div. 0.5 kN)
<b>BK 010/2R</b>	Manometer diameter 200 mm Capacity 100 kN
<b>AD 225/020</b>	"Plate Bearing Test" software



TB 637/3

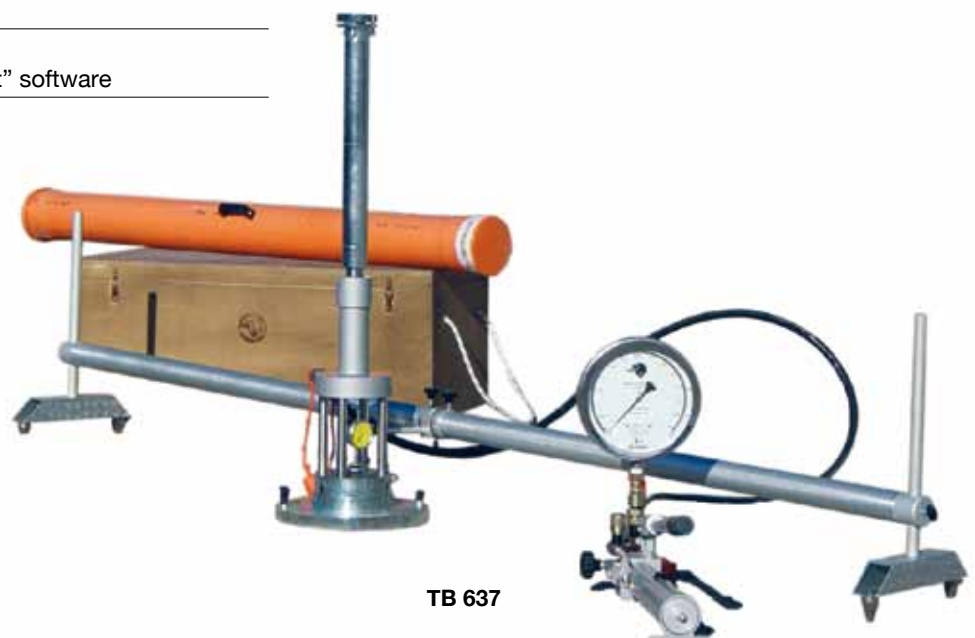

TB 637



### 3.1.3 IN SITU TESTS



TB 637/7  
TB 637/8  
TB 637/9



TB 637/2

## TECNOTEST

### SPECIAL LOAD PLATES

These plates can be used with 200 kN and 500 kN instruments. They are designed for use in a "pyramid" configuration one on top of the other. When selecting these plates the obligatory succession must be considered.

<b>TB 637/7</b>	Plate diameter 457 mm (18")
<b>TB 637/8</b>	Plate diameter 610 mm (24") for use with the above plate
<b>TB 637/9</b>	Plate diameter 762 mm (30") for use with the above two plates

### PLATE BEARING TEST EQUIPMENT 200 - 500 kN

ASTM D 1194 ASTM D 1195 ASTM D 1196 BS 1377

The purpose of the plate bearing test is to determine the bearing capacity and the load-deflection relationship of the ground or of materials used for roads, airport runways, pavements etc.

#### THE EQUIPMENT COMPRISES:

The **telescopic reference bar** has two extensions with end rods that terminate with two bearers.

During assembly the height can be adjusted.

The maximum distance between the support plates is 5.5 meters. The frame is built entirely in aluminium.

The **deflection reading assembly** comprises three dial gauges with 0.01 divisions, 30 mm stroke and adjustable clamp assembly with micrometric zero setting.

The **standard plate** (300 mm diameter) is complete with screw caps for the accurate zero setting of the three dial gauges. Additional plates (with 457, 610 and 762 mm diameters) are available upon request.

**Ball seating assembly** complete with three extensions for stroke adjustment and ballast adaptation.

**Hydraulic cylinder** has a 100 mm stroke.

**Manual hydraulic pump** complete with tank. The pump has two speeds which allow for the rapid ascent of the cylinder if there is no load. It also has a maximum pressure valve and an adaptor for load gauge connection. Quick couplings connect the pump to the cylinder.

**Load gauges** diameter 200 mm, 200 or 500 kN.

#### 200 KN PLATE BEARING TEST EQUIPMENT TB 637/2

This apparatus has a load gauge with a 200 mm diameter and full range equal to 200 kN with graduations every 1 kN.

Precision class 0.5.

The load distribution plate standard dia. 300 mm is in galvanized steel.

**DIMENSIONS TEST SET-UP:** 5500 x 800 x 750 (h) mm.

**DIMENSION DISASSEMBLED:** 2250 x 350 x 450 (h) mm.

**WEIGHT:** 60 kg approx.

#### SET OF METAL TRANSPORT CASES TB 637/02

**DIMENSIONS/WEIGHTS OF METAL CASES:** 2450 x 370 x 260 (h) mm.

**WEIGHT:** 42 kg approx.

**DIMENSIONS:** 430 x 350 x 520 (h) mm.

**WEIGHT:** 14 kg approx.

**OVERALL WEIGHT:** equipment and cases 116 kg.

**500 kN PLATE BEARING TEST EQUIPMENT TB 637/5**

This apparatus has a load gauge with a 200 mm diameter and with full range equal to 500 kN and graduations every 2 kN. Precision class 0.5. The load distribution plate is in galvanized steel.

**DIMENSIONS:**

- test set-up: 5500 x 800 x 750 (h) mm
  - disassembled: 2250 x 350 x 450 (h) mm
- OVERALL WEIGHT:** 100 kg approx.

**SET OF METAL TRANSPORT CASES TB 637/02****DIMENSIONS/WEIGHTS OF METAL CASES:**

- 2450 x 370 x 260 (h) mm, weight: 42 kg approx.
  - 430 x 350 x 520 (h) mm, weight: 14 kg approx.
- OVERALL WEIGHT:** plate + cases 156 kg.

**1000 kN LOAD TEST INSTRUMENT TB 638/100**

The hydraulic ram develops a max. force of 1000 kN over a 100 mm course for load tests on micro-piles or for plate bearing tests. Accessory TB 638/101 (steel base) is also available. The hydraulic pump has two capacities with automatic changeover from fast to slow to reduce the strain on the lever under high pressure. There is a built-in oil tank and a 5 m delivery pipe with quick couplings is supplied.

The measurement instrument supplied is a load gauge with a 200 mm diameter, class 0.5, calibrated directly in kN.

The index line is in tubular aluminium with extension pieces that give a maximum opening of 5 m. Three articulated arms hold three centesimal dial gauges with a 30 mm travel.

Hydraulic ram: 168 mm dia. x 223 mm (h).

Weight: 33.5 kg. Complete with three transport cases.

**DIMENSIONS:**

- case 1: 230 x 45 x 35 (h) cm
- case 2: 60 x 30 x 40 (h) cm
- case 3: 65 x 35 x 35 (h) cm

**OVERALL WEIGHT (PACKED):** 220 kg

**TB 638/101** STEEL BASE dia. 300 mm x 90 mm (h) with three adjustable reference points for dial gauges

**TB 638/251** EXTRA REFERENCE BAR

**2500 kN LOAD GROUP FOR BEARING TESTS ON PILES TB 638/250**

Comprises a 2500 kN hydraulic ram with 100 mm stroke and safety locknut. Ram dimensions: 268 mm dia. x 308 mm (h), weight 133 kg. Two-speed hydraulic pump has automatic changeover from fast to slow to reduce the strain on the lever under high pressure.

There is a built-in oil tank and 5 m delivery pipe complete with quick couplings as series fitting. Supplied with 200 mm diameter precision dial gauge, class 0.5. Reference bar is made of aluminium and has telescopic extensions so that a maximum opening of 5 m is attained.

The three articulated arms are each equipped with a dial gauge (0.01 divisions - 30 mm travel) are standard fitting. Complete with three carrying cases.

**DIMENSIONS:**

- case 1: 230 x 45 x 35(h) cm
- case 2: 60 x 30 x 40 (h) cm
- case 3: 65 x 35 x 35 (h) cm

**OVERALL WEIGHT PACKED:** 250 kg.

**TB 638/401** STEEL BASE dia. 400 x 100 (h) mm with three adjustable reference points for dial gauges

**TB 638/251** EXTRA REFERENCE BAR



TB 637/5



## FWD-LIGHT FALLING WEIGHT DEFLECTOMETER

(GERMAN TECHNICAL SPECIFICATION FOR SOIL AND ROCK IN ROAD CONSTRUCTION TP BF, StB PART B 8.3)

The instrument enables a quick determination of the dynamic deformation module  $E_{vd}$  of soils. It is especially suitable for testing coarse grained and mixed grained soil up to a maximum size of 63 mm in diameter.

The main advantage with respect to the traditional static test is the rapidity of measurement: it takes only 2 minutes per test point. The other advantages are: no necessity of counterbalance, possibility of use under narrow conditions.

### The instrument consists of:

- 10 kg or 15 kg falling weight
- 300 mm diameter loading plate which includes accelerometer
- Digital control unit with serial interface and miniprinter
- Rechargeable batteries 12 V, 700 mAh and battery charger
- Car electric power supply connector

Operations are guided via display which shows: date, time, the 3 deflection peaks in mm, average value of the 3 deflections and the dynamic deflection module  $E_{vd}$  in  $\text{MN/m}^2$ .

### Common features:

- Falling weight: 10-15 kg
- Loading plate: 300 mm diameter, 20 mm thickness
- Maximum amplitude of the load pulse: 7.07 kN
- Pulse width: 18 ms
- Range of deflection measurement: 0.2 to 10 mm  $\pm$  0.01 mm
- Range of dynamic deflection module:  $E_{vd}$  125  $\text{MN/m}^2$
- Range of accelerometer: 0 to 100 g
- Range of frequency: 0 to 500 Hz
- Range of temperature: 0 to 50°C

**TOTAL WEIGHT:** TB 633/B04 31 kg

**PACKED DIMENSIONS:** TB 633/B04 1280 x 280 x 300 (h) mm

**TOTAL WEIGHT:** TB 634/B05 40 kg

**PACKED DIMENSIONS:** TB 633/B04 420 x 330 x 330 (h) mm

A more advanced and practical version allows downloading the test data to a PC, instead of using a printer.

Furthermore the control unit is located in a water-proof box. Three keys (external) are used when the box cover is closed. The "chip card" with its reader allows storage of 50 tests. The software for processing data uses Windows.

### MODELS:

<b>TB 633/B04</b>	Tester with 10 kg falling weight
<b>TB 634/B05</b>	Tester with 15 kg falling weight



TB 633/B04



**BENKELMAN DEFLECTION BEAM**

TB 142/B21

CNR 141 AASHTO T 256

The Benkelman beam is used to measure the deflection of flexible pavements under the action of standard wheel-load. The appliance comprises a frame on adjustable supports and bearing the fulcrum of a moveable arm; the outer extremity of this arm rests on the ground whilst the inner extremity touches a dial gauge.

Road deflection readings are given on the dial gauge.

Tecnotest has designed and manufactured the instrument with great care to guarantee the required accuracy for measuring infinitesimal arm rotations according to lever ratio (1:4).

In order to meet such specifications, light alloys have been used for structural components, accurate machine-tooling for the assemblies and low-friction bearings for the moving components. It is equipped with a special electric vibrator actuated by a rechargeable battery in order to eliminate breakaway resistance.

Those models that are not equipped with this vibrator give deflection measurements which are systematically lower than real values, thereby rendering the test untrustworthy.

The instrument is easily dismantled for transport and is housed in a storage box. Supplied complete with centesimal dial gauge (80 mm diameter, 0.01 divisions, 30 mm travel), periscope for easy dial gauge reading.

**DIMENSIONS ASSEMBLED:** 366 x 50 x 50 (h) cm.

**DIMENSIONS PACKED:** 200 x 30 x 30 (h) cm.

**GROSS WEIGHT:** 66 kg

**NET WEIGHT:** 10 kg

**CALIBRATION UNIT**

TB 143

To ensure that the dial gauge is operating correctly and the beam is moving freely, it is desirable to check the beam before use, by means of a calibration unit.



TB 142/B21



### 3.1.3 IN SITU TESTS

#### POLISHED STONE VALUE APPARATUS (ACCELERATED POLISHING MACHINE)

TB 512

ASTM E 303 BS 812 CNR 105 EN 1097-8 EN 1388  
EN 1340 EN 1341 EN 1342 EN 1344

For determining resistance of aggregates used for road paving to surface wear caused by the polishing action of vehicle tyres. Used to prepare aggregate samples for testing resistance with a Skid Tester. Samples are prepared in special moulds and then mounted on a metal wheel. As many as 14 specimens at a time may be tested. Such specimens are brought into contact with a special tyred wheel which is subjected to increasing loads via a lever.

Corn and flour emery abrasives are fed between the wheels while a flowmeter regulates water flow. Used emery abrasives and water are collected in a removeable tray.

Wheel speed: from 315 to 325 rpm.

Standard equipment supplied with the machine includes:

- 2 tyred wheels
- 1 surcharge weight
- 2 electric dispensers for emery abrasives
- 1 flowmeter to regulate water flow
- 1 collecting tray
- 4 specimen moulds
- 2 mould plates
- rubber rings for fixing specimens to metal wheel
- set of wrenches
- safety devices

POWER SUPPLY: 220 V, 50 Hz, single phase.

DIMENSIONS: 760 x 700 x 1060 (h) mm.

WEIGHT: approx 175 kg.

##### ACCESSORIES AND SPARE PARTS:

TB 512/1	Specimen mould
TB 512/2	Plate for mould
TB 512/A	Corn emery, 25 kg pack
TB 512/B	Flour emery, 25 kg pack
TB 512/C	Ungraded control stone, 25 kg pack
TB 512/D	Ungraded Criggion stone, 25 kg pack for checking skid tester sliders
TB 512/7	Rubber tyre for corn emery
TB 512/9	Rubber ring for road wheel

#### TECNOTEST

#### SKID RESISTANCE TESTER

TB 515

ASTM E 303 BS 812 CNR 105 EN 1097-8 EN 1388  
EN 1340 EN 1341 EN 1342 EN 1344

Portable instrument for checking the resistance of road surfaces to skidding. The tester simulates, as far as possible, sliding between the vehicle tyre and the road.

The apparatus measures the frictional resistance between a special rubber slider (mounted on the end of a pendulum arm) and the road surface.

May also be used for "Polished Stone Value" test using specimens obtained using the Accelerated Polishing machine. When interpreting the results it is necessary to take into consideration the different operating conditions (wet or dry road), the kind of road (uneven or with slope), the speed etc.

Standard equipment: graduated perspex scale, additional scale for laboratory tests, 6 rubber sliders (TB 515/4) for tests on roads, thermometer, miscellaneous tools. The skid resistance tester is housed in a case for transport.

DIMENSIONS: 300 x 600 x 800 (h) mm.

NET WEIGHT: 30 kg.

##### ACCESSORIES AND SPARE PARTS:

TB 515/1	Metal base plate with specimen mounting block and slider TB 515/3
TB 515/3	Small rubber slider for laboratory use (EN 1097 - CNR 105)
TB 515/4	Large rubber slider for site use (EN 1097 - CNR 105)
TB 515/A	Specimen holder for test specimens 136 x 86 mm (EN 1338 - 1340 - 1341 - 1342- 1344)
TB 515/5	Large rubber slider for use with TB 515/A
TB 515/B	Specimen holder for test specimens 42 x 86 mm for use with TB 515/3 (EN 1341 - 1342)

N.B.: TB 515/A and TB 515/B must be secured to base TB 515/1 which is therefore to be ordered at the same time.



TB 512

WITH ACCESSORIES



TB 515

WITH ACCESSORIES

**“MOT” STRAIGHT EDGE** **TB 511/5**

UNI EN 13036-7

For measuring any irregularities in road surface.  
Made entirely in aluminium, 5 m long.  
Supplied complete with two measuring wedges.

WEIGHT: 21 kg.

**“MOT” STRAIGHT EDGE** **TB 511**

Same as TB 511/5 but 3 m long.

WEIGHT: 14 kg

**“MOT” STRAIGHT EDGE** **TB 511/4**

Same as TB 511/5 but 4 m long

WEIGHT: 19 kg

**SAND PATCH EQUIPMENT****TEXTURE DEPTH** **TB 094**

CNR 94

The set comprises:

- Duraluminium calibrated cylinder 25 cc.
- Duraluminium spreader disc, rubber faced, (shore A 60 hardness).
- Soft brushes and flexible rule
- Natural siliceous sand (riddled 0.160 to 0.315 mm grain size) 15 kg in plastic container (TB 094/S1).
- Folding windshield made of aluminium

**ACCESSORIES AND SPARE PARTS:**

BS 598 ASTM E 965 EN 13036-1

<b>V 753</b>	Pycnometer (glass) - Two pieces required
<b>V 233/A</b>	Plastic cylinder, 25 cc
<b>V 233/B</b>	Plastic cylinder, 50 cc
<b>TB 094/S</b>	Calibrated sand, 150/75 micron, 15 kg
<b>TB 094/S1</b>	Calibrated sand, 315/160 micron, 15 kg
<b>DV 094</b>	Screw-adjusted divider
<b>TB 094/V</b>	Glass spheres: 250/180 micron. 5 kg bag
<b>DV 229/4</b>	Wire brush (185 x 70 x 50 mm)



TB 511/5



TB 094

### 3.1.3 IN SITU TESTS

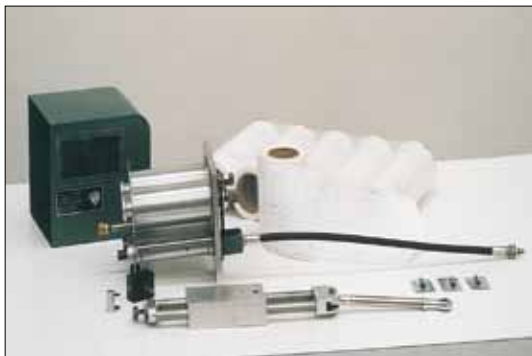

TB 144

TB 144/B  
TB 144/A

TB 099



TB 508

### TECNOTEST

#### TRAVELLING BEAM DEVICE

TB 144

Comprises a 3 m long beam on wheels and is used for checking irregularities in both concrete and bituminous road surfaces.

A sensor unit and central wheel assembly measures deviation of the surface from a straight-line shown on an indicator with 4:1 magnification with a scale calibrated in increments of 2 mm to 10 mm and 5 mm to 25 mm.

Suspect areas are identified using a dye marker.

The device is both easy to manoeuvre and easy to assemble hence a single operator is sufficient.

Supplied complete with outrigger wheels.

**DIMENSIONS PACKED:** 1860 x 610 x 650 mm.

**WEIGHT:** 100 kg.

#### ACCESSORIES AND SPARE PARTS:

**TB 144/B** Autographic recorder unit

May be fitted to the sensor unit of the travelling beam device to provide a permanent record of the surface profile. Records up to a kilometre can be recorded on the special chart paper (to be ordered separately with felt-tip pens).

**WEIGHT:** 6.2 kg.

**TB 144/A** Pack of 10 chart rolls and 10 pens

The charts are calibrated in units of 2 mm up to 10 mm, units of 5 mm up to 25 mm and will record up to a distance of 1 kilometre.

**WEIGHT:** 2.3 kg.

#### RATE OF SPREAD OF COATED CHIPPINGS

TB 099

BS 598

Comprised by a metal tray measuring 300 mm square used in conjunction with a spring balance secured by chains and hook to determine the rate of spread of chippings.

Up to 10 trays are generally used during the test.

**TB 099/V** Tray measuring 300 mm square and relative chains

#### COATING THICKNESS GAUGE

TB 508

This easy-to-use Elcometer gauge permits non-destructive measurements of coating thickness of bitumens or other non-magnetic materials on ferrous metals such as bars having min. dia. 3 mm and concave surfaces having min. dia. 25 mm. Accuracy  $\pm 10\%$ .

Standard range 0-600  $\mu\text{m}$  (0-25 mils/thou)

Supplied with case, operating instructions and foils.

**DIMENSIONS:** 90 x 50 x 25 (h) mm.

**WEIGHT:** 185 g.





